

# User's manual for the FSU 975 single fiber fusion splicer by Ericsson

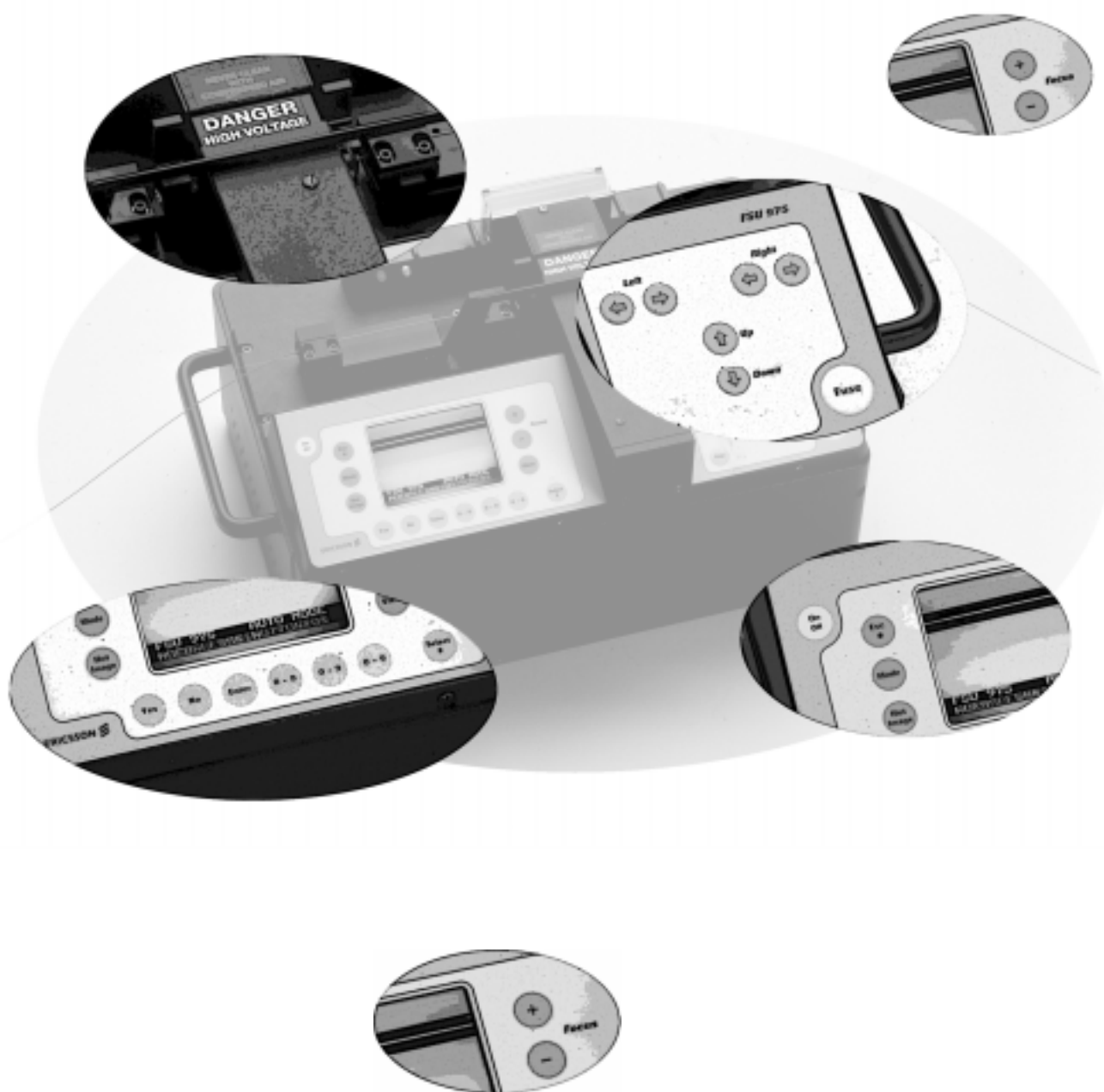



# Table of contents

Introduction .....	4
Safety Information .....	5
Description of the FSU 975 .....	6
Setting up the splicer .....	8
<b>BASIC OPERATION .....</b>	<b>9</b>
Splicing quick guide .....	9
Fiber preparation .....	10
Splicer preparation .....	12
Splicing mode and program selection .....	14
Automode splicing .....	17
Manual mode splicing .....	18
Splice evaluation .....	21
Splice protection .....	23
<b>ADVANCED OPERATION .....</b>	<b>25</b>
Fusion program structure .....	25
Overview .....	25
Program name .....	26
Fiber type .....	26
Splicing process .....	28
Program parameters .....	34
Pre-defined programs: Programs 01 - 10 .....	38
Program editing: Programs 11 - 50 .....	40
Parameter editing review .....	50
Special functions .....	52
Quick character selection .....	52
Global parameters: Program 00 .....	52
Service functions: #-button .....	56
Advanced hot image analysis .....	59
Advanced splicing parameters .....	60
<b>Maintenance .....</b>	<b>62</b>
Power connection .....	62
Fiber clamps and V-grooves .....	63
Electrodes .....	64
Mirror one .....	66
Maintenance time table .....	66
<b>Software package .....</b>	<b>67</b>
<b>Appendices</b>	
A-Troubleshooting .....	68
B-Technical Data .....	71
C-Parameter and program editing flow charts .....	72
<b>Index .....</b>	<b>77</b>
<b>Ericsson representatives .....</b>	<b>79</b>

# Introduction



*FSU 975*

The FSU 975 is designed to be “the only single fiber splicer you’ll ever need.” It handles all basic single fiber splicing procedures, as well as more complex tasks such as tapering, attenuator making and erbium splicing. At the heart of the splicer’s operations is the hot core alignment process, which individualizes the splicing procedure to fit your fiber type and climactic conditions in order to offer the lowest possible splice loss every time. Then, just to make sure, the FSU 975 estimates this splice loss with an extremely accurate splice loss estimation technique based on mode coupling theory (micro-bending) and hot image processing.

There are two ways of categorizing the FSU 975’s operations, and this manual will be organized according to both them:



*Operations*

On the one hand, the FSU 975 splicing programs can be divided into two groups: Programs 01 - 10, which are the ten splicing programs that come pre-defined with the machine, and Programs 11 - 50 which are the forty editable slots you have for designing your own splicing programs to suit your special needs. In this manual, the instructions you will need to run the pre-defined programs (01 - 10) will be the focus of the section on “Basic Operation.” After you are familiar with the FSU basics, you can go on to the second section, “Advanced Operation,” which outlines the structure of splicing programs in greater detail, and describes the method for designing your own.

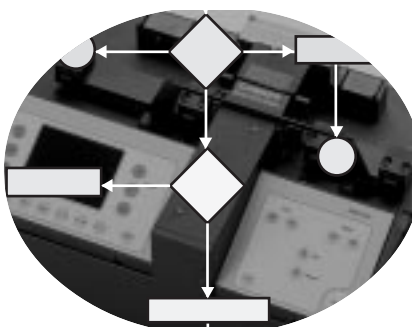

*Processes*

On the other hand, FSU 975 splicing programs (including the pre-defined ones) can be organized according to five splicing processes: normal splicing, hot core alignment, mode field matching, attenuator making, and pulling or tapering. Whereas, this cross-cut of FSU operations will be only mentioned briefly in the section on “Basic Operation”, it will play a large role in “Advanced Operation.” Generally speaking, even though you will not need to specify splicing processes when using the pre-defined programs, it always helpful to keep splicing process in mind when discussing any splicing program, since it specifies the steps the FSU 975 goes through when splicing.

## Safety Information

### Operational Precautions

- **Do not use** the splicer in locations where there is a risk of **explosion**.
- **Never touch** the electrodes when the splicer is on.
- **Never open** the safety shield or the power supply during operation.
- **Never loosen** any screws except those mentioned in this manual, since you may harm important adjustments.
- **Do not insert** objects other than stripped and cleaned optical fiber or cleaning and maintenance tools into the splicer.

### Maintenance Precautions

- Never use hard objects to clean the V-grooves or electrodes. Use the supplied brush, or in the case of the V-grooves, isopropyl alcohol and cotton swabs.
- Never use acetone for cleaning any part of the splicer.
- Never use cans with compressed gas to clean any part of the splicer.
- Keep the electrode housing clean and dry at all times.
- Use the electrode cleaning program after every time you clean or change the electrodes, otherwise the arc will be unstable.

### Transport and Storage

- Never leave your splicer in direct sunlight or in places where it might be exposed to excessive heat (such as in vehicles parked in the sun).
- Always transport the splicer in its carrying case to avoid damage to its precision parts.
- Keep the humidity to a minimum where the splicer is stored. The humidity must not exceed 95%.
- If moisture forms on the optics when moving the splicer from an area with very cold temperature to a warmer environment, let the splicer sit and warm up before using it.
- Close the safety shield during transport.

General rule is...

The FSU 975 is a precision instrument, and must be treated as such.

## Description of the FSU 975

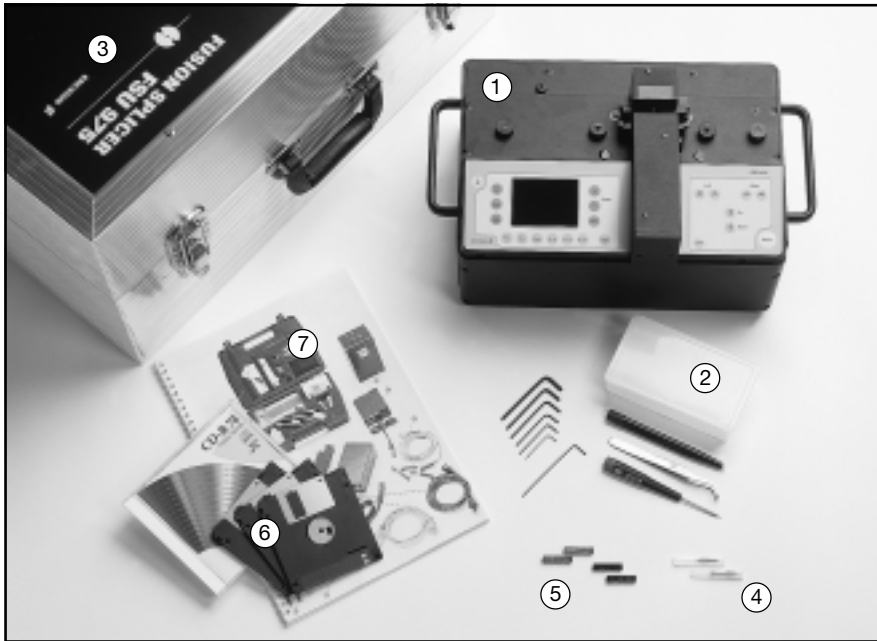

The FSU 975 is delivered in a rugged, cabin-size carrying case along with the basic set of tools you need to get started splicing.

- ① FSU 975 fusion splicer
- ② Tool set with one electrode brush, one set of tweezers, a seven piece hexagonal key set, and one hex wrench
- ③ Carrying case
- ④ Pair of spare electrodes
- ⑤ Two pairs of V-grooves
  - Blue (125  $\mu$ m/1mm)
  - Black (250  $\mu$ m/2mm)
- ⑥ Software package
- ⑦ User's manual

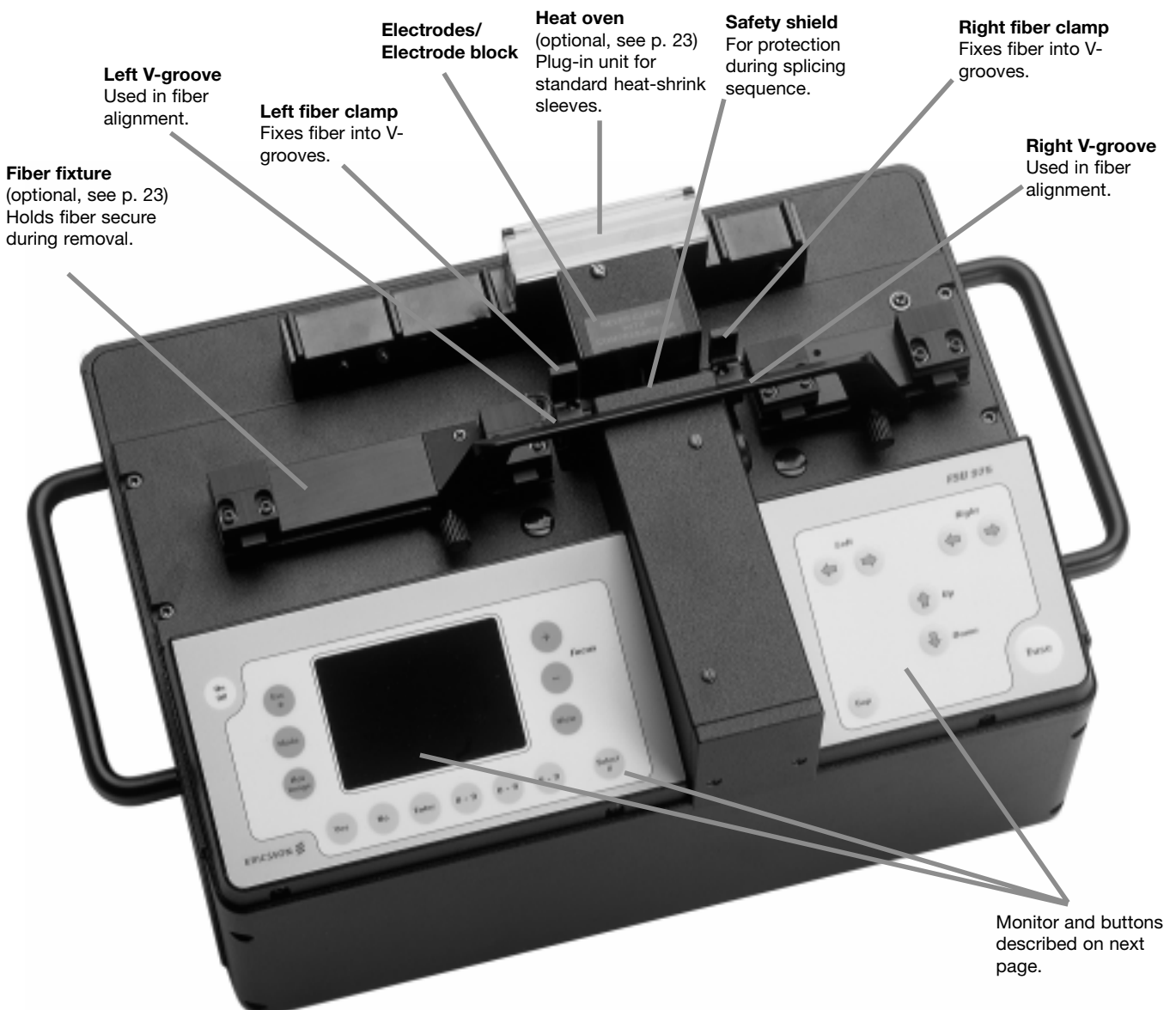

## Rear panel

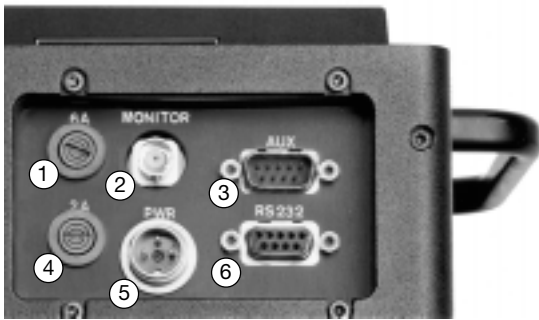

- ① 6A Fuse
- ② Output for video
- ③ Auxiliary 12V video output (see Appendix B)
- ④ 2A Fuse
- ⑤ 12V power input
- ⑥ RS 232 (see Appendix B)

## Buttons

Buttons		FSU 975	
	<p>On/Off To turn splicer on and off.</p> <p>Esc/* To abort operations and to access parameters.</p> <p>Mode To change splice mode</p> <p>Hot Image To flip through hot images.</p>	<p>Left arrows To move left fiber along its own axis (e.g. toward right fiber).</p> <p>Right arrows To move right fiber along its own axis (e.g. away from left fiber).</p>	
Programming buttons	Yes To answer "yes" to programming questions.	Up arrow For axial fiber alignment.	
	No To answer "no" to programming questions.	Down arrow For axial fiber alignment.	
	Enter To enter one's selections.	Gap To set a fine gap or close a gap.	
	0-9 To choose first numerical place.*	Fuse To initiate a splicing procedure.	
	0-9 To choose second numerical place.*		
0-9 To choose third numerical place.*			
Select/# To check battery and to access service parameters.			
Monitor Controls	+ To adjust focus.		
	- To adjust focus.		
	View To change content of monitor.		

\* For example, to get the number '147', you would press the first button once, the second button 4 times, and the third 7 times.

## Monitor

The FSU 975 monitor is organized into a viewing area that allows you to see the fibers from two different angles, and a text area that is itself divided into two text fields: a *mode field* and a *message field*. The *mode field* informs you which mode and programs you are working with. The *message field* poses questions, gives instructions and tells you what it is doing.

Fibers from 1st angle

If you press VIEW, you then see the fibers from the 2nd angle.

Mode field

Message field

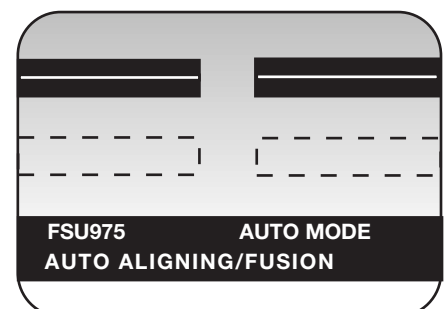

## Setting up the splicer

The adjacent set-up checklist is not in any way exhaustive, but it does present the basics you should have at hand before sitting down and splicing.

### Set-up checklist

- |  |  |
|--|--|
| <input type="checkbox"/> Optical fiber     | <input type="checkbox"/> FSU 975 fusion splicer    |
| <input type="checkbox"/> Fiber holders     | <input checked="" type="checkbox"/> FSU 975 manual |
| <input type="checkbox"/> Strippers         | <input type="checkbox"/> V-grooves                 |
| <input type="checkbox"/> Cleaner           | <input type="checkbox"/> Heat-shrink oven          |
| <input type="checkbox"/> Cleaver           | <input type="checkbox"/> Heat-shrinkable sleeves   |
| <input type="checkbox"/> Cotton swabs      | <input type="checkbox"/> Power supply or battery   |
| <input type="checkbox"/> Isopropyl alcohol |  |
| <input type="checkbox"/> Electrode brush   |  |

### V-grooves

The FSU 975 is delivered with two sets of V-grooves, blue V-grooves and black V-grooves:

Use the **blue V-grooves** when you intend to clamp on bare fiber. They are designed for fiber with tight secondary coating with a cladding diameter of up to 125  $\mu\text{m}$  and secondary coating diameter of up to 1 mm. (See also p. 11).

Use the **black V-grooves** when you intend to clamp on primary coating. They are designed for fiber with a nominal primary coating of 250  $\mu\text{m}$ , as well as, loose-tube secondary coated fibers with a tube diameter of up to 2 mm. (See also p. 11).

It is also possible to order specially designed V-grooves from Ericsson by contacting your local service representative. If you do indeed need to change V-grooves, or install them for the first time, you should follow the instructions on page 63.

### Power connection

The FSU 975 can be operated by either a 12 V DC battery or a power supply unit rated at 50-60 Hz. In both cases the power cord is connected into the outlet marked PWR on the rear panel of the splicer (see also diagram of rear panel on previous page). If you are using the battery delivered by Ericsson, keep in mind that the battery is not charged on delivery (see p. 61).

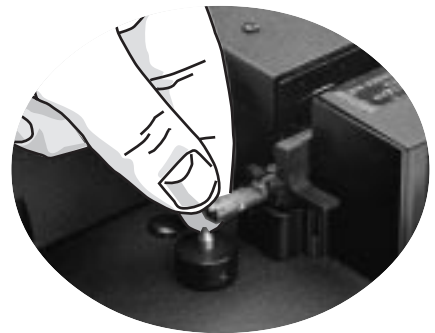

# BASIC OPERATION - Quick guide

The following steps outline basic operation of the FSU 975, and refer to the pages where they are explained in greater detail.

**1** **Connect the splicer to the power supply** ..... 8



**2** **Prepare the fibers** ..... 10  
*Strip, clean and cleave the fibers.*



**3** **Turn on the splicer and place the fibers** ..... 12  
*Note: The splicer will turn off automatically when you re-open the safety shield after splicing.*



**4** **Select splicing mode and program** ..... 14  
*Choose between the two splicing modes: Automode and Manual mode. (Note that the splicer always starts in Automode when just turned on). A list of the pre-defined splicing programs (01-10) is found on page 16.*

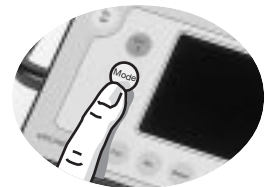

**5** **Splice the fibers** ..... 17  
*Press the fuse button.*



**6** **Check the splice** ..... 21  
*Check the splice visually by pressing VIEW and scrolling through stored images. Evaluate the splice quantitatively by taking note of the estimated splice loss.*



**7** **Protect the splice** ..... 23  
*Protect the splice with a heat-shrinkable sleeve.*

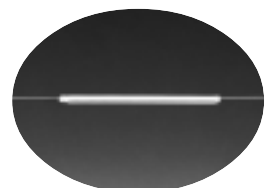

# Fiber preparation

## 1 Slip on a heat-shrinkable sleeve

Easily forgotten, yet so frustrating. Remember to always slip a heat-shrinkable sleeve onto one of the fibers at the beginning of fiber preparation.

## 2 Strip the fiber

First remove at least 50mm of secondary coating (true for both tight and loose tube secondary coating) with a stripper appropriate to the type of coating you have. Then remove around 25 mm of the primary coating with a stripper designed for primary coating. (See also pictures below).



It is important that you do not put undue stress on the fibers by bending or crimping them.



Illustrations of strippers for secondary and primary coating



Loose tube secondary coating



Tight secondary coating



Primary coating

## 3 Clean the fiber

Clean the bare fibers with a tissue or a pair of cotton swabs soaked in **propanol** or **ethanol**.

**It is important that from this point on you are very careful with the fibers to ensure that they do not become dirty again** (such as laying them down on a dusty working surface, or even waving them around in the air).

It is also a good idea at this stage to check to be sure the **V-grooves** are clean, and if not, wipe them down as well.



## 4 Cleave the fiber

Before cleaving the fiber, make sure the fiber is clean and properly prepared (See steps 1-3).

Cleave the fibers using a high quality cleaving tool that offers a flat end-face at an angle of less than  $1^\circ$  from the perpendicular. To ensure good splicing, you must also observe the instructions for cleaving lengths detailed below.

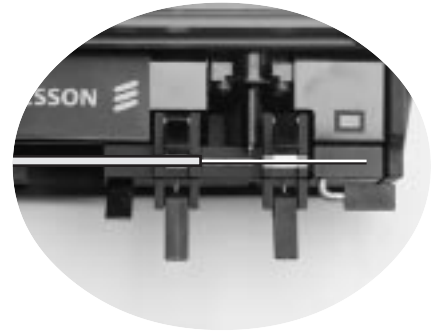

### Cleaving lengths (plus V-groove selection)

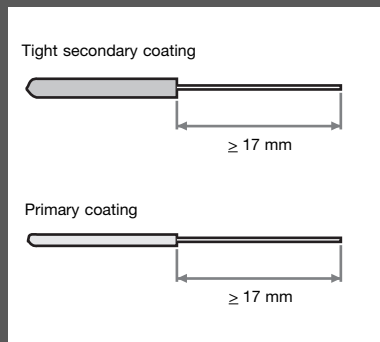

Use Blue V-grooves  
(Clamping on bare fiber)

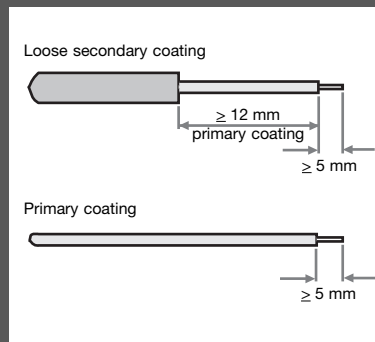

Use Black V-grooves  
(Clamping on primary coating)

### Fiber preparation checklist

Fiber preparation is often the decisive phase in successful splicing, so it is important to ensure that you can check off on the adjacent points.

#### Fiber preparation checklist

- The correct V-grooves have been selected
- The fiber clamps and V-grooves are clean
- The fibers are completely stripped
- The fibers are clean
- The end-faces are well-cleaved
- The correct cleaving lengths have been achieved

# Splicer preparation

## 1 Turn on the splicer

Turn on the splicer by pressing the ON/OFF button in the upper left-hand corner. (Remember that the splicer will turn off automatically when you open the safety shield after splicing.)

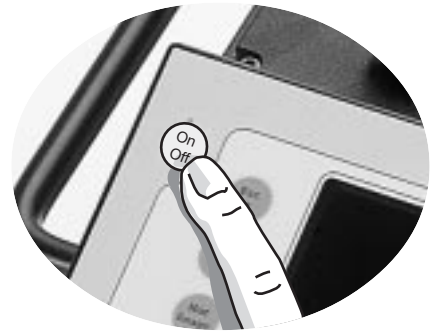

The splicer always starts in Automode, and thus will read "FSU 975 AUTO MODE" in the *mode field*. In the *message field* you will get a message telling you that it is calibrating parameters. Once calibration is completed, the splicer will tell you to "INSERT FIBERS" and to "CLOSE SAFETY SHIELD."

“ FSU 975 AUTO MODE  
PARAMETER UPDATING...  
INSERT FIBERS  
CLOSE SAFETY SHIELD ”

## 2 Insert fibers

Place the fibers into the V-grooves until they are visible in the monitor, and then close the clamps. Make sure to avoid sliding the fibers along the V-grooves, but rather position them over the V-grooves and then tilt them down into place (see picture below).

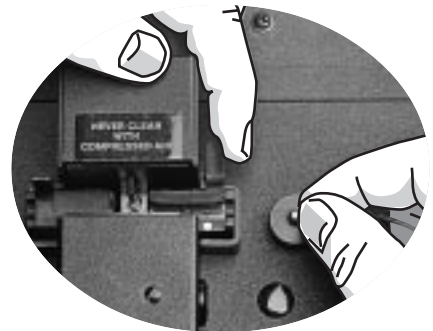

Proper (and not so proper) insertion of the fibers:

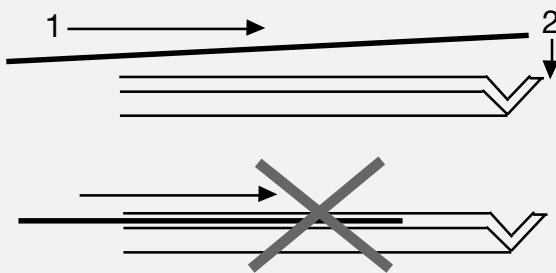

### 3 Close the safety shield

Once you have placed the fibers so that you see them in the monitor and closed the fiber clamps, you must also close the safety shield by sliding it smoothly into place.



At this point the messages, "CLOSE SAFETY SHIELD" and "INSERT FIBERS" will be replaced with a new series of messages. The first will inform you which splicing program was last used (for example, "SM + SM P01"). The other messages will tell you about coming next stages in the splicing process: "AUTO ALIGNING/FUSION" and "PRESS FUSE BUTTON." But first....

“ **Program name Program #**  
(eg. SM + SM P01)  
**AUTO ALIGNING/FUSION**  
**PRESS FUSE BUTTON** ”

### 4 Check the fibers

Before you take any more steps toward splicing, you should check the fibers in the monitor to make sure they are clean and well-cleaved. (See illustrations below for examples of problems). If you see any defects, you should take the fibers out and re-prepare them. Don't forget to check both views, which you can alternatively access by pressing VIEW.

If you are having difficulty seeing the fibers, you should try adjusting the focus by pressing the buttons (+) and (-).

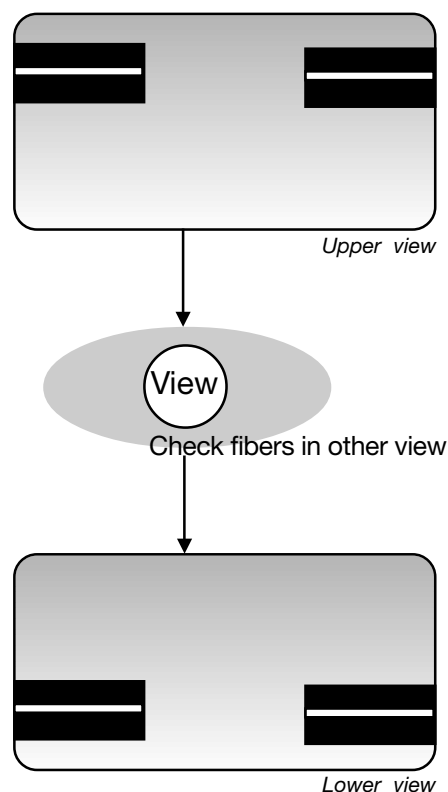

The following pictures represent fiber preparation defects that necessitate re-preparation of the fibers.

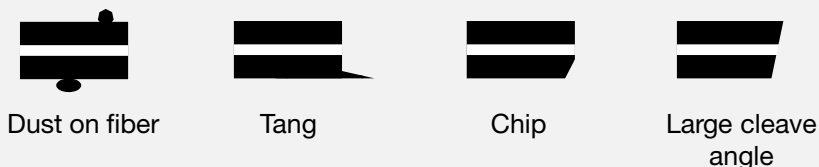

# Splicing mode and program selection

Though the splicer is saying in the *message field* to “PRESS FUSE BUTTON,” you should make sure the correct splicing mode and program are selected.

## 1 Select splicing mode

As mentioned earlier, the default splicing mode is Automode, and this will be the mode the splicer is in when you just turn it on. In Automode, the splicer automatically carries out fiber alignment and initiates fusion. However, if you want to manually align the fibers and initialize splicing, you can change to Manual mode by pushing the MODE button. The *mode field* will then read to “FSU 975 MANUAL MODE.” To change back to Automode, just push MODE again. Remember that you can always check which mode you are in during splicer preparation by reading what is displayed in the *mode field*.

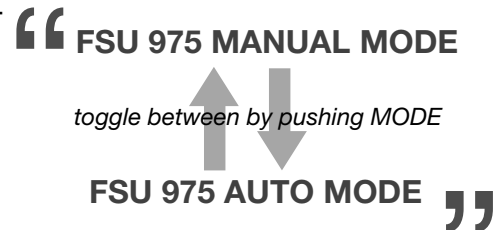
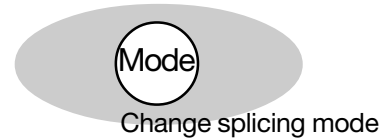

## 2 Select splicing program

In this section on *Basic Operation*, we are only going to use the pre-defined programs (Programs 01-10) as examples, but you would follow the same selection procedure if you wanted to load in one of your own programs created through the instructions outlined in the section on *Advanced Operation*.

**A** The first step is to press the ENTER button. At this point both the *mode* and the *message field* will change. The *mode field* will display the current splicing program, and the *message field* will ask you if you want to change it. For the purposes of demonstration, we are going to assume that the current splicing program is program 01, NORMAL SM +SM.

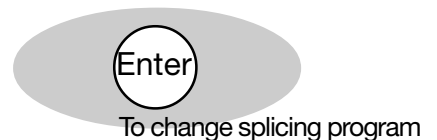

**B** If you press (Yes), the message field will then be open for you to enter a new program.

If you press (No), you will jump to step F.

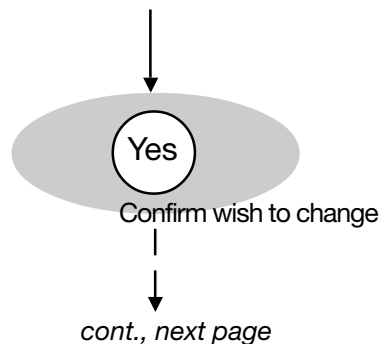

To see a list over the pre-defined programs (Programs 01-10), you can either look on page 16 of this manual, or follow the instruction in optional step BB on the next page as to how you can access the screen-viewer.

**BB** As an optional step, you can then press VIEW to see the screen-viewer with a list over all of the the splicing programs in memory. To scroll through the pages, press VIEW.

To escape from the screen-viewer, press ESC.

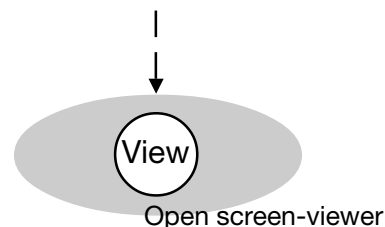

**C** To select a new program, you can either scroll through the programs using the and buttons, or you can type in the number of the program you want using the first two numerical buttons (from the left). Let's say we wanted to splice titanium fibers (P03). To do so we would either press the button twice, or type in "0" with the first numerical button and "3" with the second.

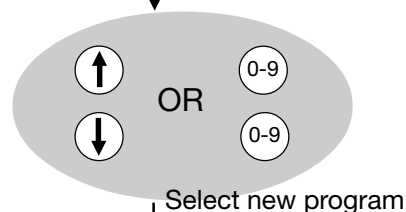

**D** You then confirm your selection by pressing ENTER.

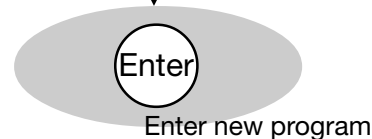

**E** The *mode field* will then display your new selected program (In our example, "TITAN SM + SM"), and in the *message field* the splicer will ask if you want to change the program again. If you are satisfied with the splicing program displayed, press .

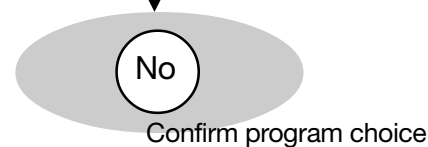

**F** The splicer will then ask whether you want to edit parameters. Splicing program editing is a function taken up in the section on Advanced Operation (see p. 40), but you should keep in mind that it is not possible to edit the parameters in Programs 01-10 (the ones we are using here as examples). So to end splicing program selection and return to splicing mode, you should press again.

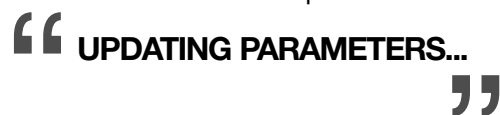
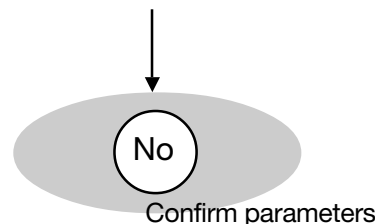

The splicer will then update the parameters in memory so they match those of the splicing program you have chosen, and return to splicing mode (see definition, following page)

## Splicing programs 01-10

Program Name	Prog. No.	Fiber type	Splicing process*
NORMAL SM + SM	01	Standard single fiber	Normal splicing
DSF SM + SM	02	Depressed cladding fiber	Normal splicing
TITAN SM + SM	03	Titanium fiber	Normal splicing
NORMAL MM + MM	04	Multimode fiber	Normal splicing
ECCENTRIC SM + SM	05	Standard single fiber with eccentric core	Hot core alignment
ERBIUM + SM MCVD**	06	Erbium fiber with single fiber	Mode field matching
ERBIUM + DSF OVD**	07	Erbium fiber with dispersion shifted fiber	Mode field matching
SM ATTENUATOR	08	Standard single fiber	Attenuator making
SM FIBER LENS	09	Standard single fiber	Pulling or tapering
SM 80 UM MICRON	10	Single fiber with 80 µm core	Normal splicing

\* Splicing processes are explained in the section on Advanced Operation, see p. 28.

\*\* MCVD and OVD refer to fiber production methods, and respectively stand for “Modified Chemical Vapor Deposition” and “Outside Vapor Deposition.”

### Viewing splicing program parameters

If you wish to look at a listing of the splicing program parameters for a particular program you should press ENTER, as if you wanted to change splicing program, and then, rather than answer “Yes” or “No” to the question “New program?,” press VIEW. This will bring up the screen-viewer for the program in memory (see adjacent example). You can flip through pages by pressing VIEW, and when you are finished reviewing the parameters, you press ENTER to exit the screen-viewer (or press YES or NO, thereby directly entering the sequence for splicing program selection at step B, see p. 14). You should keep in mind, though, that this is only an option for non-confidential programs.

```

STANDARD FIBER
NORMAL SPLICING
-----
PREFUS TIME           0.2 S
PREFUSE CURR         10.0 MA
GAP                   50.0 UM
OVERLAP               10.0 UM
FUSION TIME 1         0.3 S
FUSION CURR 1        10.5 MA
FUSION TIME 2         2.0 S
FUSION CURR 2        16.3 MA
FUSION TIME 3         2.0 S
FUSION CURR 3         2.0 S
LEFT MFD              9.8 UM
NORMAL SM+SM           P01
NEW PROGRAM?
    
```

Screen-viewer with parameters for Program 01

### Splicing mode

The term “splicing mode” in singular is not to be confused with the two splicing modes: Automode and Manual mode. When the FSU 975 is “in splicing mode,” or “returns to splicing mode,” it means that it is ready to splice on your command. In short, it represents a state of splicing readiness. The FSU 975 exits splicing mode whenever you press ENTER to select a program or to edit a program.

# Automode splicing

## 1 Splicer ready

At this point you should have chosen Automode for the splicing mode (see p. 14), and a splicing program. Continuing with the example taken up in the section on splicing program selection, we will assume you have chosen Program 03. This will give you the adjacent screen, with “FSU 975 AUTO MODE” in the *mode field* and the program name and program number in the *message field*.

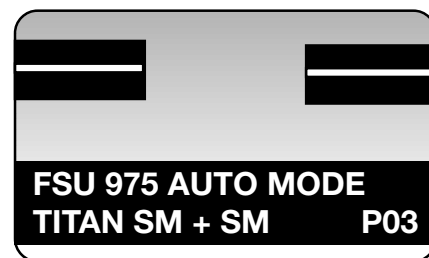

Once the fibers are in place and the safety shield has been closed, the splicer will then display a series of messages in the *message field* that tell you that it is ready.

“ AUTO ALIGNING/FUSION

PRESS FUSE BUTTON ”

## 2 Start splicing

To start the automatic splicing sequence press FUSE. The splicer will then automatically rough align the fibers, prefuse, focus the view, fine align the fibers, and finally fuse them.

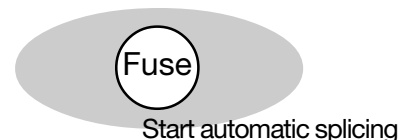

During the entire sequence the chosen splicing program will be displayed in the *mode field* (in our example, “TITAN SM + SM P03”), while in the *message field* the splicer will keep you abreast of what it is doing.

“ TITAN SM + SM P03

ROUGH ALIGNMENT  
PREFUSION WILL START  
ROUGH ALIGNMENT  
ALIGNING FIBERS  
SPLICING WILL START  
SPLICING...”

If at any point the splicer cannot carry out some part of the automatic sequence, a fault message will appear in the *message field*. If this occurs you should look at Troubleshooting in Appendix A, p. 67.

If at any point you want to interrupt the automatic sequence, press the  button. To then re-start the splicing sequence, press FUSE.

# Manual mode splicing

## 1 Splicer ready

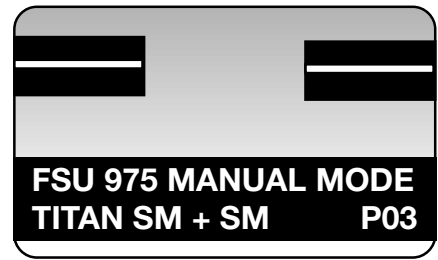

At this point you should have chosen Manual mode for the splicing mode (see p.14), and a splicing program. To continue our example, we will assume you have chosen Program 03 for titanium fiber splicing. This will give you the adjacent screen, with “FSU 975 MANUAL MODE” in the *mode field* and the program name (“TITAN SM + SM”) and program number (P03) in the *message field*.





The splicer will then display a series of messages in the *message field* that tell you that it is ready.

“ **READY FOR PREFUSING** ”  
**PRESS FUSE BUTTON** ”

## 2 Roughly align fibers

In order to roughly align the fibers with respect to each other, you should alternately press the  and  buttons for both the right and left fibers until the outer edges of the fibers line up.

When you think the fibers are lined up, you can start bringing the fibers towards each other by alternatively pressing the  and  buttons for each of the fibers. Your goal is a gap equivalent to half a diameter of a fiber, centered horizontally in the monitor (see illustration below).

You should then press the VIEW button to ensure that the gap is also correct from the other camera angle.

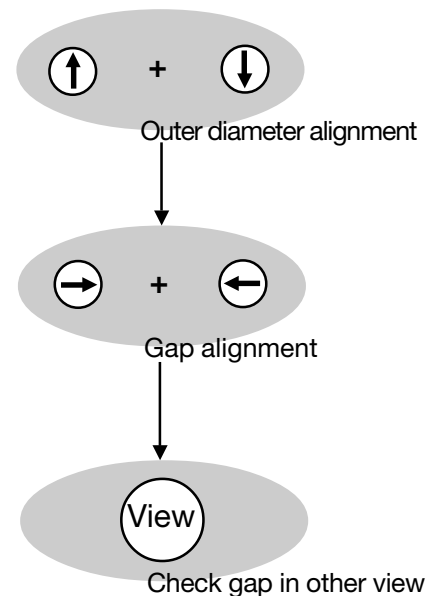

After rough alignment the situation should be as follows: the outer edges of the fibers line up, and the gap between their end-faces is the width of half a fiber diameter, and centered on the monitor.

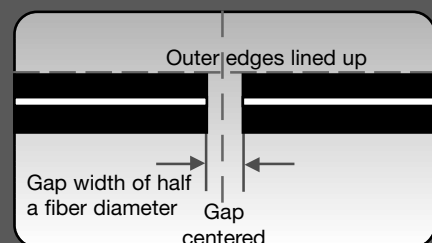

### 3 Prefuse



Once the fibers are rough-aligned, you press the FUSE button. During prefusion the fibers are cleaned by low level heating.

After prefusion is complete the splicer sends new messages to the *message field*, telling you it is waiting for you to complete final inspection and alignment.

### 4 Inspect fiber



This is your last chance to check the fibers before splicing, so you should switch between the two viewing angles by pressing VIEW button, looking for dust or any other imperfections. If dust remains, or you see any other problems you should abort the splicing procedure and re-prepare the fibers. For examples of problems you should watch out for, see p 13.



### 5 Fine-tune alignment



Now that you have assured yourself that the fibers are clean and of good quality, you can fine-tune their alignment. In order to set the gap, you use the  and  buttons, bringing the fibers as close together as possible without overlap.

The last movement before you set the gap must be to move the fibers inwards (closer together).

You then briefly press the GAP button. The resulting gap should be as narrow as possible, but still wide enough to allow for free movement of the fibers up and down (see illustration on next page).

After you have set the gap, do not press the  and  buttons.

Using the  and  buttons you can now fine-tune the alignment of the outer fiber edges, making sure that the two fibers line up straight across the screen.

If at any point, you feel the view is not clear, use the  and  buttons to improve the focus.

Do not forget to fine-tune the alignment from both camera angles, which you can toggle between by pressing VIEW.

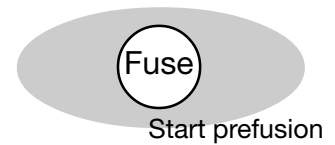

“ **READY FOR SPLICING**  
**PRESS FUSE BUTTON** ”

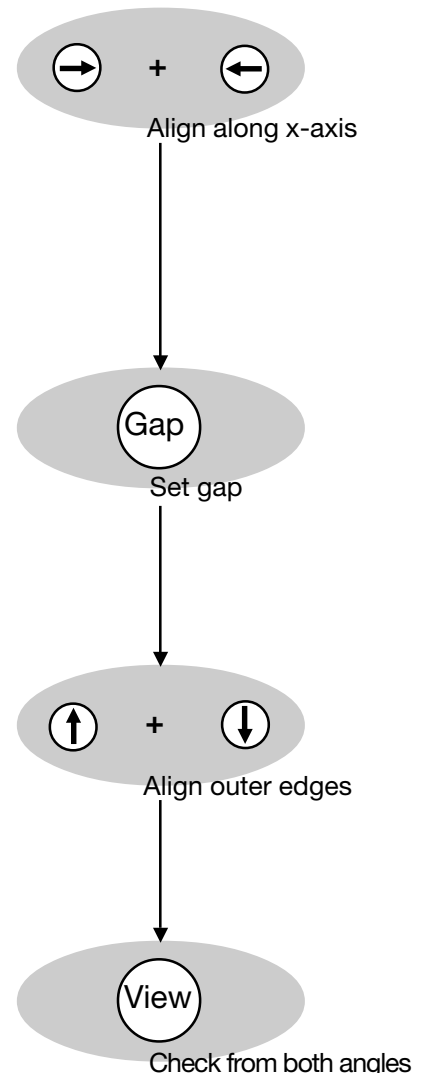
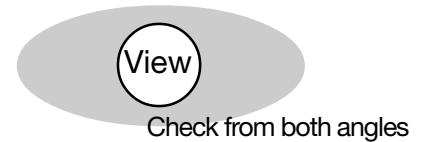

After fine-tuning, and before fusion, the alignment should be as follows: the outer edges of the fibers line up, and the gap between their end-faces is centered on the monitor and as small as possible while still allowing for up and down movement of the fibers.

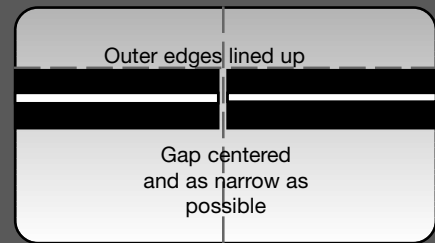

## 6 Fuse

When the fibers are aligned to your satisfaction, you can press the FUSE button and start fusion. The splicer will follow the splicing program you chose earlier: in our case, program 03.

As the FSU 975 splices your fibers, it will read “Splicing....” in the *message field*.

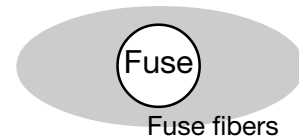

“ SPLICING...” ”

## 7 Check the splice

Once the splicing sequence is complete, you need to check the splice. The steps for this procedure are outlined in the following section.

# Splice evaluation

## 1 Loss estimation

After the splicing sequence is complete, the splicer automatically estimates the splice loss and displays it in the *mode field*.

“ FSU 975 AUTO MODE  
CHECKING SPLICE ”

“ ESTIM. LOSS: x.xx dB  
NEXT PICTURE, VIEW ”

## 2 Re-fuse: Optional step

This option is **not** available if you are using the hot core alignment process (Program 05, in the case of the pre-defined programs).

With all other splicing processes, if you judge that the splice loss is too high, you can try to lower it by re-fusing. The splicer will present this option to you in the mode field, and you effectuate it by pressing FUSE again.

“ ESTIM. LOSS: x.xx dB  
FOR REFUSING  
  
PRESS FUSE BUTTON ”

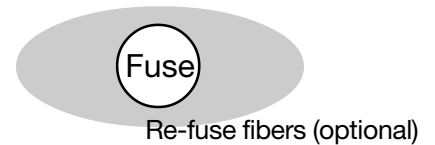

Do not re-fuse more than once, because multiple re-fusion can result in reduced splice strength and/or increased splice attenuation.

## 3 Evaluate splice visually

You should also visually evaluate the splice. The sequence of images available includes the two live images (one from each angle) and two stored hot images that are photos taken during splicing. You can scroll through all of them by repeatedly pressing VIEW.

Image evaluation shows you the result of the splicing procedure, as well as, what happened during the splicing process, and is a particularly rich source of information for troubleshooting. On the next page there are some tips as to what you should look for.

The FSU 975 also offers more advanced functionality in relation to hot image analysis, and if you are interested in using it, you should read page 59 in Advanced Operation.

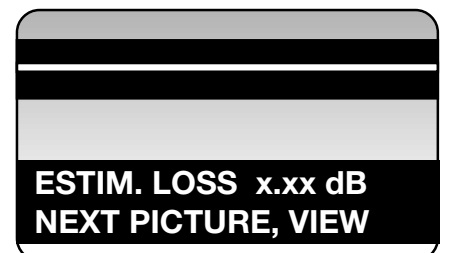

Example of a live image

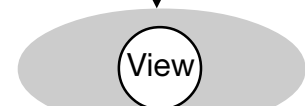

To scroll through images

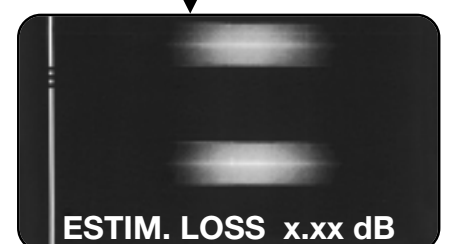

Example of a hot image

## Live image and basic hot image analysis

The best thing to have in your mind as you look at the images after splicing is a representation of a successful splice, such as the one here. The thing to note in particular is that the core and the outer edges form straight lines. If your splice does not look like this, you should check for one of the common splice defects shown below.

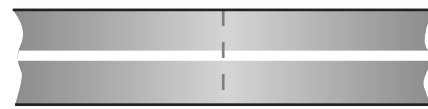

Example of a successful splice

### Bent core

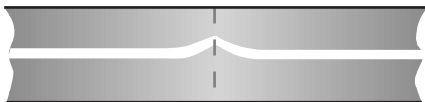

This is when the core, rather than form a straight line, bends at the splice point. A bent core is most often caused by a bad cleave, and is thus a problem that can be remedied by careful re-preparation of the fibers.

### Core offset



This is where the cores of the original fibers do not line up, even though their claddings do. This is most often the result of fibers with large core eccentricity, and you should use the Hot core alignment process with them when re-splicing.

### Hot spot



A hot spot shows up as a bright point on the fiber. It can be the result of a variety of factors: dirt on the fiber, poor cleaving, or air bubbles inside the fiber. When a hot spot is located outside the core, it reduces splice strength, when inside the core, it also contributes to higher splice loss. The best action to take is to carefully re-prepare the fibers.

### Bulge

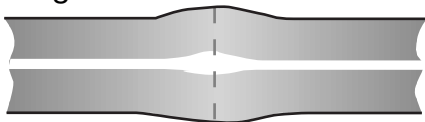

A bulge in the outer diameter usually indicates that you have used the wrong splicing program parameters, so you should check the program you are using before re-splicing.

### Waisting

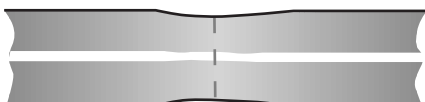

When the splice area is thinner than the fiber diameter, it means that either the fusion current was too high or that the fibers did not overlap sufficiently during splicing. You should check the program parameters before re-splicing.

### Matchsticking

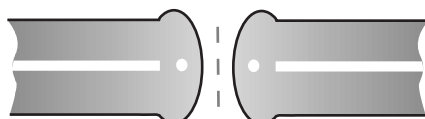

A number of problems can cause matchsticking. The most common causes are excessive fusion currents, dirty electrodes, and presence of primary coating left on the fibers. You should check these things and re-splice.

Throughout the splicing process, but especially during visual splice evaluation it is important to keep in mind the following: Whereas the white line one sees in hot images is the core, it is NOT in live images. Rather, the white line one sees in a live image is nothing more than the result the round fiber acting as a lens and focusing the light shining through it.

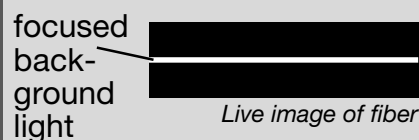

## Splice protection

### 1 Remove the fiber

Once you are satisfied that you have a successful splice, you can open the safety shield--at which point the splicer will automatically turn off--and release the fiber clamps. You should then carefully transfer the spliced fiber to the heat oven. The simplest way to achieve this procedure without putting unnecessary torsional tension on the fiber is to use the fiber fixtures available for the FSU 975 (see adjacent picture).

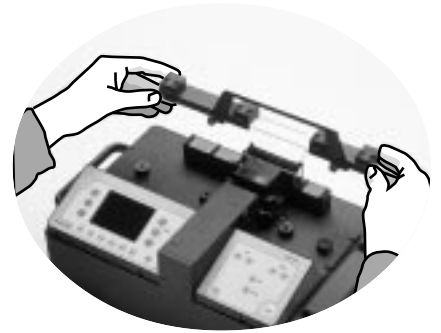

### 2 Apply the heat-shrinkable sleeve

Make sure the heat-shrinkable sleeve is positioned over the splice area, and then carefully place the fiber into the heat oven. You should then follow the instructions that come with the heat oven. The heat oven is designed to evenly shrink the sleeve over the fiber, thereby protecting it without sealing in any bubbles that might cause attenuation problems.

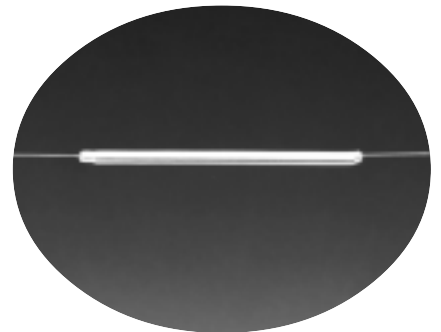



# ADVANCED OPERATION - Program structure overview

The following elements form the backbone to all FSU 975 splicing programs. Each will be described in greater detail on the indicated pages.

**A Program name** ..... 26  
*Certain limitations hold in splicing program names.*



**B Fiber type** ..... 26  
*Various fiber types behave differently when spliced, so the fiber type must be correctly specified in a splicing program.*

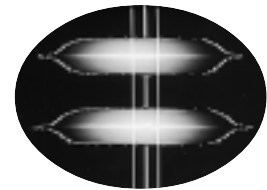

**C Splicing process** ..... 28  
*There are five different splicing processes available with the FSU 975.*



**D Program parameters** ..... 34  
*The parameters contain the quantitative information needed to execute the various splicing programs. They are permanently set in the case of the pre-defined programs, however, can be edited in the case of Programs 11-50.*



# Splicing program structure

## A Program name

The names of FSU 975 splicing programs can have no more than 16 characters, and should be designed for quick and easy recognition. When a splicing program is displayed, it will always be with its number, like the pre-defined programs are:

“ **NORMAL SM + SM P01** ”



## B Fiber type

Because of structural differences, different types of fiber behave in dissimilar ways when spliced. For example, dopants can change the melting temperatures and light emissions of heated glass, and fibers are often made with several differently doped layers. This variation must be taken into account during the splicing sequence, as well as in splice loss estimation, so it is important to specify fiber type when designing your own program. As an aid, the following descriptions of the major fiber types are given with a listing of the programming name for that fiber type, as well as, the number(s) of the pre-defined splicing program(s) that can be used as a base for designing your own splicing programs.

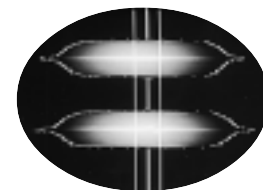

### Erbium doped fiber

### ERBIUM DOPED FIBER

Pre-defined programs: 06 & 07

Erbium doped fiber is used in amplifiers to increase the intensity of a light signal within an optical network. It achieves this through a combination of erbium dopants and a smaller than average core (usually 4 μm, as opposed to 6-8 μm). However, since erbium fiber is usually being spliced to other types of fiber with larger cores, special techniques must be applied to make the best match of the dissimilar cores.



Hot image of erbium + single mode fibers

### Multimode fiber

### MULTI-MODE FIBER

Pre-defined program: 04

Multimode fiber has a larger core that permits the transmission of several light modes simultaneously, and since it does not have any mechanisms for dampening dispersion, it is usually only used in smaller, local networks. On the other hand, its advantage is that it is relatively easy to splice. If you are ever not sure whether you have multimode fiber, it is quite easy to identify it by looking at its distinctive hot image profile.

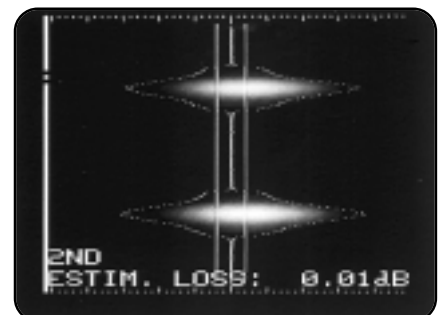

Hot image of multimode fibers

## Depressed cladding fiber

### DEPRESS. CLAD. FIBER

Pre-defined program: 02

Depressed cladding fibers are doped with both germanium in the core and fluorine in the inner part of the cladding. The purpose of this double-doping is to reduce dispersion at a chosen wavelength. As with titanium doped fibers, the increased radiation from the dopants makes it difficult to distinguish the core in hot images, so a special filtering technique must be applied. The other difficulty you might encounter is that the dopants have a tendency to diffuse during splicing, resulting in higher splice loss.



Hot image of depressed cladding fibers

## Dispersion shifted fiber

### DEPRESS. CLAD. FIBER or INVISIBLE CORE FIB.

Pre-defined program: 02

Like depressed cladding fiber, dispersion shifted fiber is designed to achieve a low level of dispersion at a chosen wavelength. And again like depressed cladding fiber, the dopants used to create the necessary gradation of refractive indexes, make the core very difficult to see in hot images. Because of their similarities, you can specify "DEPRESS, CLAD. FIBER" with dispersion shifted fiber; however, if the splice loss is too high using this fiber type specification, you should select "INVISIBLE CORE" instead.



Hot image of dispersion shifted fibers

## Silica core fiber

### INVISIBLE CORE FIB.

Pre-defined program: 02

Silica core has the same difficulty as dispersion shifted fiber: namely that the high level of dopants (in this case fluorine in the cladding) can make it nearly impossible to see the core.

## Titanium fiber

### TITANIUM FIBER

Pre-defined program: 03

Titanium fibers have an outer layer doped with titanium dioxide, which has the result of increasing the fiber's resistance to fatigue. A splicing difficulty is that this titanium doped layer, when heated, emits more radiation than the cladding, making it hard to see the core in hot images. Another peculiarity is that splicing titanium fibers contaminates the electrodes more quickly than other splicing combinations. To minimize this contamination, as well as the risk of "matchsticking"--a phenomenon where the fibers do not fuse, but rather melt at their tips forming round balls at their ends--a program with a lower current should be used.

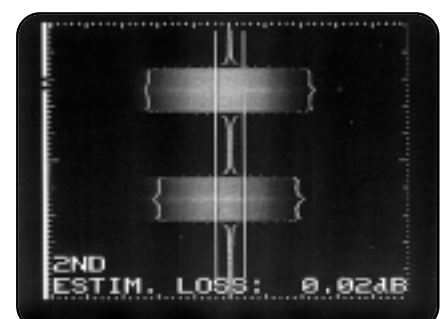

Hot image of titanium fibers

# C Splicing process

Splicing processes represent a way of dividing splicing programs into groups according to the way the splicer carries out the splicing sequence. The FSU 975 is organized around five different splicing processes:

- Normal splicing..... 28
- Hot core alignment ..... 29
- Mode field matching..... 30
- Attenuator making ..... 32
- Pulling or tapering ..... 33

The following descriptions will outline the special operations and considerations involved with each splicing process, as well as, the necessary control parameters to run these operations (to read more about control parameters, see the section on program parameters, p.35). Like the explanation of fiber types, each description will be headed with a list of the pre-defined programs that use the splicing process, and thus can serve as a base for your own program.

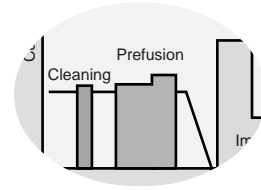

The diagrams included with the splicing processes are actually two superposed graphs. The bar graph represents the electrode currents with respect to time. The line graph represents the fiber distance with respect to time.

## Normal splicing

Pre-defined programs: 01-04, 10

The normal splicing process is suitable for standard single and multimode fibers with a core to cladding eccentricity (ie. how much the core is not centered in the fiber) of less than 0.6 μm. There are no special control parameters associated with normal splicing.

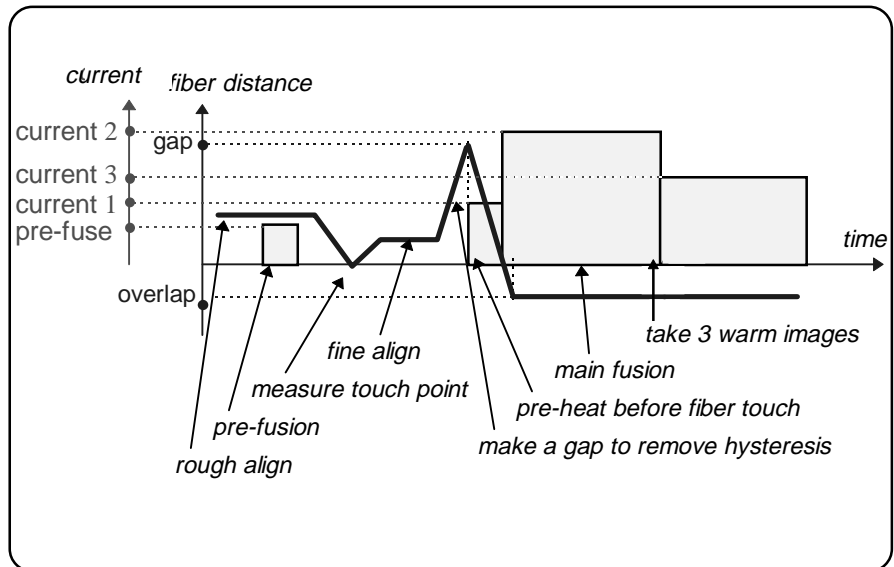

A typical splicing sequence for the normal splicing process

## Hot core alignment

Pre-defined program: 05

Hot core alignment is designed for single fibers with a core to cladding eccentricity greater than  $0.6 \mu\text{m}$ . To be able to line up and splice fibers who are not susceptible to the normal splicing method of lining up the claddings with the assumption that the cores will thereby also be aligned, the FSU 975 makes use of hot images and real time control (RTC).

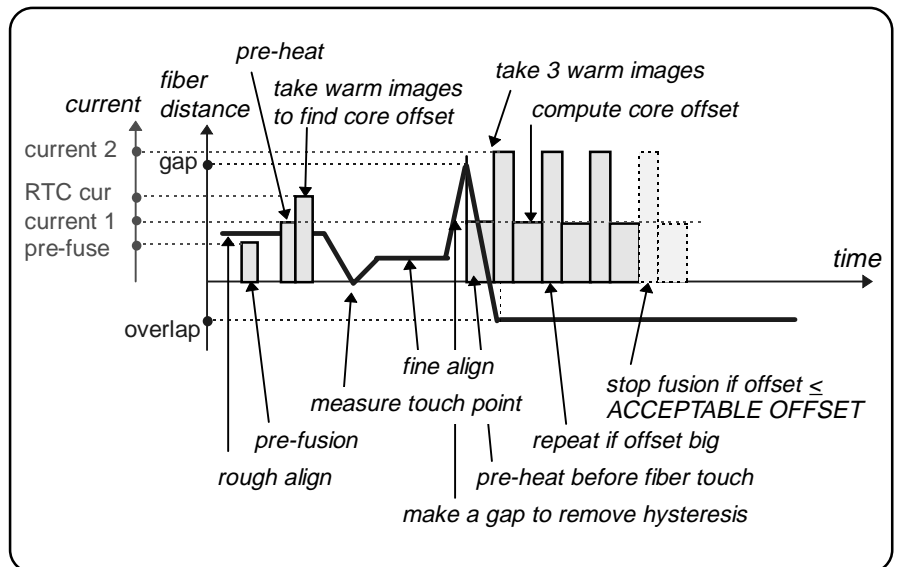

A typical splicing sequence for the hot core alignment process

The FSU 975 employs hot image analysis and RTC in the hot core alignment process to overcome the two main difficulties associated with highly eccentric cores. The first difficulty is that the splicer must locate the cores and align them properly. The second difficulty is that alignment of the eccentric cores inevitably means that the claddings will not line up. This would not be such a problem in and of itself if it were not for the fact that the misalignment of the claddings leads to surface tension during fusion that bends the fibers, and pulls the cores back out of alignment (see adjacent image).

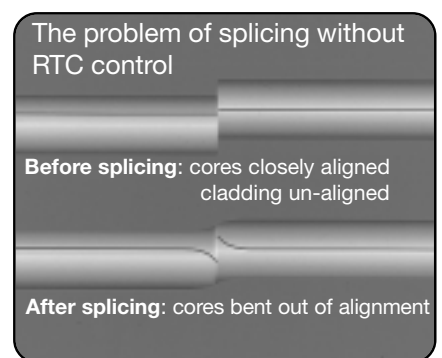

Bending of fiber cores in fibers spliced without RTC

## Hot core alignment control parameters

### MAX. ECCENTRICITY

is used to decide whether the fibers should be spliced at all. To determine whether the maximum allowable eccentricity has been exceeded, the splicer takes hot images before splicing. If this reading is above the value of the parameter, you will receive a warning in the monitor, and the splicing sequence will stop.

### ACCEPTABLE OFFSET

regulates whether a RTC sequence with its compensatory elements or a normal splicing sequence will be used to splice the fibers. It can be that the offset measured in the first part of the process is so small (ie. is acceptable) that it is just as well to line up the claddings and splice normally.

### RTC CURRENT

is the current applied to take the hot images needed for measurement of the eccentricity of the fibers (as described previously). You can set it manually, or use the current test (see p. 56), which sets it automatically.

- **FUSION CURRENT 2** is not specifically a hot core alignment parameter, but you should take note that if you choose a value of  $0.0 \text{ mA}$ , the current test sets this parameter automatically the same time it determines the RTC CURRENT. Otherwise you will have to set it manually.

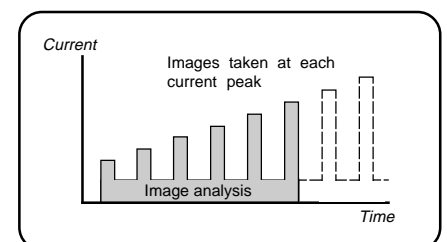

Model of current test

## Mode field matching

Pre-defined programs: 06 & 07

The mode field matching process is intended for splicing fibers with very dissimilar mode field diameters. That is to say: Different types of fiber require different diameter cores to carry their fundamental mode. Erbium fiber, for example, has a smaller than average core, and when you want to splice an erbium fiber with another type of fiber, you must find some way to make the transition from one core to the other as smooth as possible in order to avoid power loss around the unmatched core edges. This is achieved by means of a hot fiber index profile. During splicing, a fiber's dopants will diffuse into its core, decreasing its index profile. With two fibers this can result in a convergence of their profiles. With RTC this process can be observed and the arc stopped when the best match of profiles has been achieved.

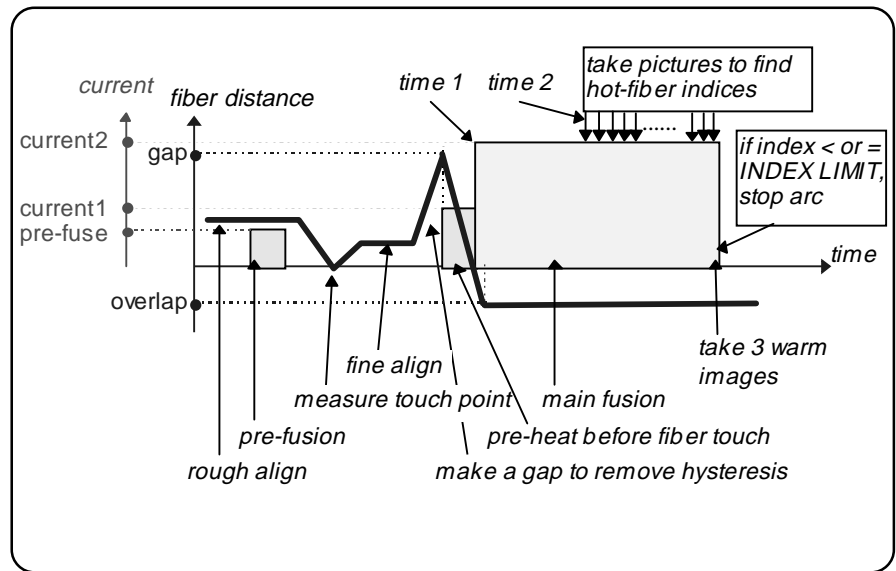

A typical splicing sequence for the mode field matching process

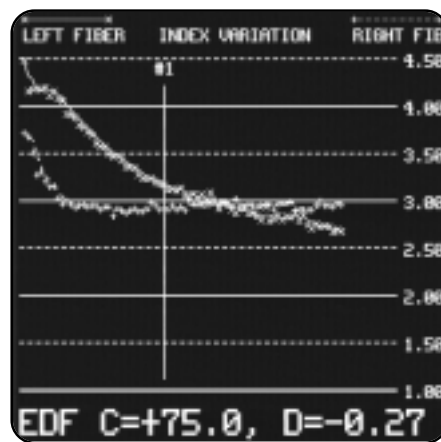

A graph from a Threshold type test (see p.31) plotting of the index profiles for two fibers. Note how the profiles converge.

## Mode field matching control parameters

### INDEX LIMIT

represents the lowest value the hot fiber index will be allowed to reach before the arc will shut off, thus ending the splicing sequence. We recommend that the first time you splice a new fiber combination that you run the Threshold type test (see next page).

### THRESHOLD TYPE

represents the type of comparison that should be made between the hot fiber index profiles for the two fibers. The easiest way to set the Threshold type is by running the Threshold type test (see next page).

### LOSS FACTOR

is a compensatory variable used in splice loss estimation to account for the difference between INDEX LIMIT (the value entered in the parameter) and the measured index after splicing.

## Threshold type test

When you are presented with a new fiber combination it is highly advisable to run the Threshold type test. You do so by setting the parameter THRESHOLD TYPE to Threshold type test (see page 40, for instructions as to how you edit parameters), as well as setting up the test configuration shown below. During the Threshold type test, you will get an index profile of the two fibers based on how they behave during heating (see picture on previous page). The result of the test will be a value for the Index limit, as well as, the information necessary to choose a Threshold type. While the test is running, it is recommended to do a splice loss measurement, as well, which you do by pressing the #-button when the loss is at a minimum. You can save up to three data points (eg. press the #-button three times) for the splice loss measurement, and the final value will be their average.

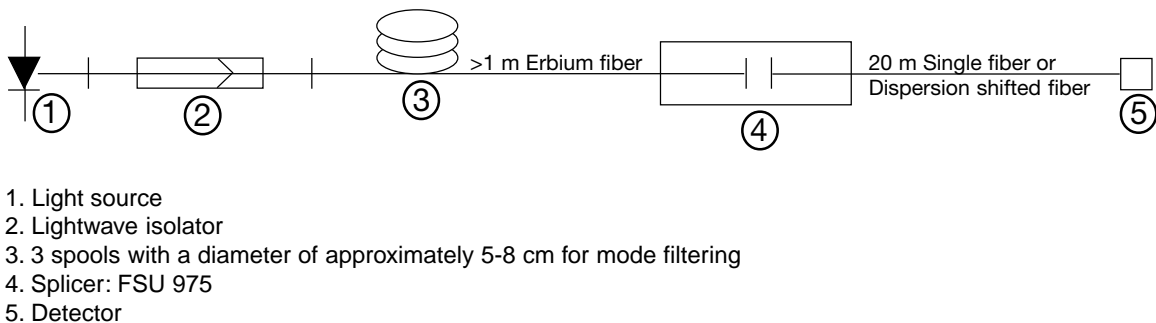
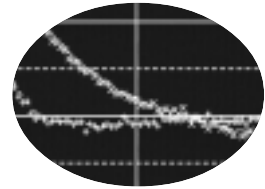

Set-up for the threshold type test

## Threshold types

### DIFFERENCE

When the difference between the two index profiles decreases during splicing, it is possible to determine the optimal match by just measuring the difference between the two index profiles, stopping the splicing sequence when the difference is at a minimum.

### LEFT INDEX and RIGHT INDEX

When the difference between the two index profiles does not become smaller during splicing, it is necessary to measure the absolute indexes of the fibers, rather than their difference. You should measure the fiber who has the least variation in its index profile.

If the left fiber's index varies least, choose LEFT INDEX  
 If the right fiber's index varies least, choose RIGHT INDEX.

### HIGHER INDEX

When one fiber always has a higher index profile than the other or when the profiles cross frequently during heating, it is best to measure the higher absolute index.

### HIGHER START

It is also possible to choose to measure the absolute index of the fiber that has the higher index in the first cycle of measurement.

## Attenuator making

Pre-defined program: 08

Attenuator making is the process you use when you want to reduce the strength of a signal--because of a short distance between a transmitter and receiver, for example. This signal strength reduction is achieved by splicing fibers with a cladding offset (and thus a core offset) that gives the desired attenuation. The FSU 975 makes use of the same RTC control that we have seen with other splicing processes to measure and set the offset.

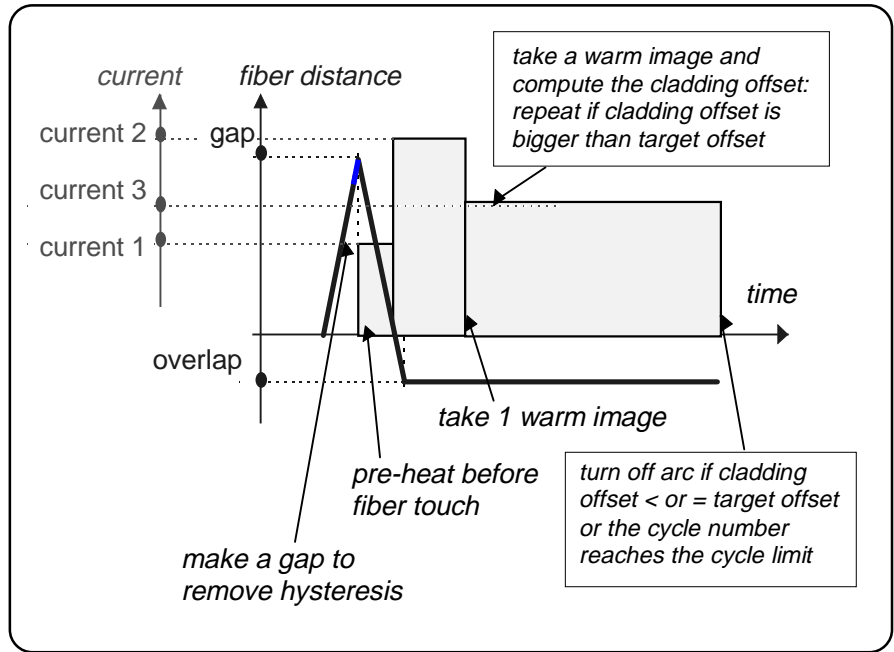

A typical splicing sequence for the attenuator making process

## Attenuator making control parameters

### DESIRED ATTENUAT.

is measured in dB, and quantifies the desired attenuation--the degree to which you want to reduce signal strength. If you select a value greater than 0 dB, as well as, give the mode field diameters for each of the fibers in the parameters LEFT MFD and RIGHT MFD, the splicer will automatically set a target offset for the desired attenuation.

### OFFSET ADJUSTMENT

is the means by which you can adjust the target offset (the intended offset after the splicing sequence). The value you enter here will be added to the target offset calculated by the splicer. To make the value negative, you should use the  $\ominus$  button.

### ECF FACTOR

when set at a value between 1 and 10, compensates for the surface tension mentioned in relation to hot core alignment (p. 29) that bends the cores out of alignment. If, on the other hand, it is set to 0, RTC is disabled, and if set above 10 it determines the limit to the number of RTC cycles (see below) the splicer will carry out before ending the splicing sequence automatically (see above diagram).

### RTC cycles

A RTC cycle is the time it takes the FSU 975 to take a hot image and analyze it. It is essential to all of the processes which make use of RTC control--hot core alignment, mode field matching and attenuator making. Though you can only explicitly give a value for the desired number of cycles during attenuator making, the splicer automatically sets limits in other cases. One such example is the Threshold type test (see p. 31), during which the splicer will run no more than 100 cycles (i.e. collect one hundred data points) before ending the test automatically.

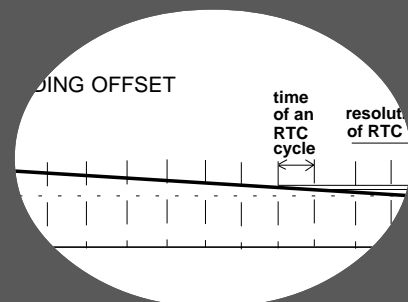

## Pulling or tapering

Pre-defined program: 09

Pulling or tapering is used primarily to create micro-lenses and microscope fiber probes out of fiber end-faces. During the process, the splicer simultaneously pulls and heats the fibers into an hour glass shape that eventually divides at the tip. This tapering process increases the mode field diameter to give the fiber a higher numerical aperture. To then capitalize on this phenomenon to make a micro-lens, the ends are made to take on a semi-spherical form which can focus light from an external source into the core.

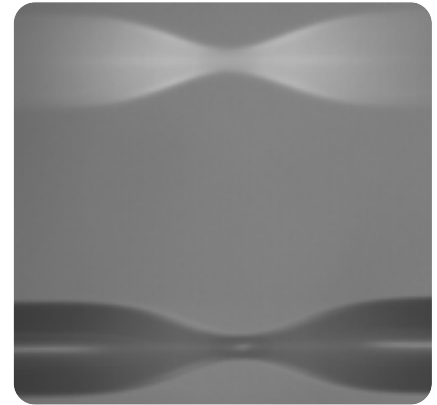

*Hour-glass form at the end of the first pulling step using Program 09*

## Pulling or tapering control parameters

### PULL 1, PULL 2, PULL 3

are the three parameters controlling the pulling or tapering process. They represent three rounds of pulling, and each is associated with the FUSION CURRENT and FUSION TIME carrying the same number (eg. FUSION CURRENT 2 is the current used during PULL 2). The PULL parameters are binary and can only be turned off or on.

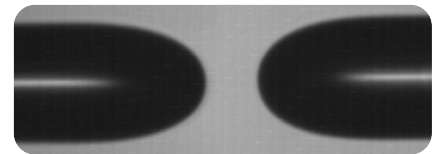

*Example of micro-lenses formed using Program 09*

### Sample program for creating fiber probes

FUSION CURRENT 1	12 mA
FUSION TIME 1	15 sec.
PULL 1	Yes
FUSION CURRENT 2	10 mA
FUSION TIME 2	5 sec.
PULL 2	Yes
FUSION CURRENT 3	7 mA
FUSION TIME 3	10 sec.
PULL 3	Yes

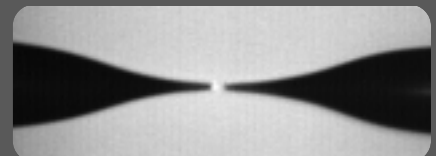

*Example of fiber probes for a microscope*

## D Program parameters

The program parameters are the variables used by each splicing program to guide the splicing sequence. The FSU 975 distinguishes three sets of program parameters: the general parameters, the control parameters and the splicing parameters. The following tables will list all of these parameters, along with their ranges of possible values and default values.

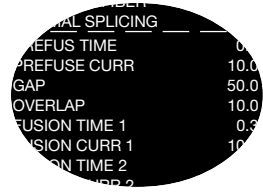

### General parameters

The general parameters hold information that concerns the overall structure of the splicing program.

Parameter	Function	Range	Default
PROGRAM NAME	Max 16 character name	All characters except "@"	<i>empty</i>
KEY NUMBER	Max 3-digit security code	000 - 999	000
SECURITY TYPE	0 = Open (available to all) 1 = Read only 2 = Confidential	0 - 2	Open (=0)
FIBER TYPE	Specifies fiber type: 0 = Standard fiber 1 = Titanium fiber 2 = Depress. clad. fiber 3 = Erbium doped fiber 4 = Invisible core fiber 5 = Multimode fiber	0 - 5	Standard fiber (=0)
PROCESS TYPE	Specifies splicing process: 0 = Normal splicing 1 = Hot core alignment 2 = Mode field matching 3 = Attenuator making 4 = Pulling or tapering	0 - 4	Normal splicing (=0)

## Control parameters

The control parameters are the parameters that control the specific operations of each of the splicing processes, and the following table organizes them accordingly. For more detail, you can also refer to the preceding section on splicing processes (pp. 28-33). Additionally, you should note that **there are no control parameters for the normal splicing process.**

	Parameter	Function	Range	Default
Hot core alignment	MAX.ECCENTRICITY	Max core to cladding eccentricity	0.00 - 9.99 $\mu\text{m}$	1.0 $\mu\text{m}$
	ACCEPTABLE OFFSET	Max acceptable core offset	0.0 - 9.9 $\mu\text{m}$	0.3 $\mu\text{m}$
	RTC CURRENT	Heating current for initial RTC images	6.0 - 29.9 mA	11 mA
Mode field matching	INDEX LIMIT	Min acceptable hot fiber index	0.0 - 9.99	0.4
	THRESHOLD TYPE	Comparison method for hot fiber indexes (see also p. 31) 0 = Threshold type test 1 = Difference 2 = Left index 3 = Right index 4 = Higher index 5 = Higher start	0 - 5	0
	LOSS FACTOR	Adjusts splice loss estimation	0.00 - 9.99	0.35
Attenuator making	DESIRED ATTENUAT.	Desired level of attenuation	0.0 - 29.9 dB	0
	OFFSET ADJUSTMENT	User adjustment added to target offset (Offset as seen in upper view)	-9.99 - 9.99 $\mu\text{m}$ (use +/- buttons to change sign)	0
	ECF FACTOR	Surface tension compensation factor/ RTC control parameter*	00.0 - 99.0	1.5
Pulling or tapering	PULL 1	Controls first round of pulling	YES/NO	YES (=1)
	PULL 2	Controls second round of pulling	YES/NO	YES (=1)
	PULL 3	Controls third round of pulling	YES/NO	YES (=1)

\*ECF = 0: RTC disabled  
 0<ECF<1.0: Align offset = Computed offset *and* Target offset = ECF x computed offset  
 1.0<ECF<10.0: Align offset = ECF x target offset *where* Target offset = Computed offset  
 ECF > 10: Fixed number of RTC cycles where number of cycles = ECF - 10

Align offset = The offset the splicer sets at the beginning of the splicing sequence.

Computed offset = The offset calculated by the splicer based on DESIRED ATTENUAT. and RIGHT MFD and LEFT MFD.

Target offset = The intended offset at the end of the splicing sequence.

## Splicing parameters

The splicing parameters are the parameters that control the general operations of the splicing sequence. Regardless of splicing process, the following parameters are applied to guide the splicer through alignment, prefusion and fusion.

*Nevertheless, some of these parameters are used slightly differently during particular processes. If this is the case, the parameter's special use will be indicated in italics.*

Parameter	Function	Range	Default
PREFUSE TIME	Time prefusion current runs	0.0 - 9.9 sec	0.2 sec
PREFUSE CURRENT	Current during prefusion	0.0 - 29.9 mA	10.0 mA
GAP	Gap set right before splicing	0.0 - 99.9 $\mu\text{m}$	50.0 $\mu\text{m}$
OVERLAP	Overlap during splicing	0.0 - 49.9 $\mu\text{m}$	8.0 $\mu\text{m}$
FUSION TIME 1*	Fusion time before the fiber ends touch	0.0 - 99.9 sec	0.3 sec
FUSION CURRENT 1	Fusion current before the fiber ends touch <i>During Hot core alignment it is the initial RTC current</i>	0.0 - 29.9 mA	10.5 mA
FUSION TIME 2	Fusion time after the fiber ends touch <i>During Mode field matching and Attenuator making it also represents the waiting time before the RTC procedure begins.</i>	0.0 - 99.9 sec	2.0 sec
FUSION CURRENT 2	Fusion current used from the point the ends touch <i>During Hot core alignment, if it is set to 0, the auto-current will be used.</i>	0.0 - 29.9 mA	15.0 mA
FUSION TIME 3	Relaxation time <i>During Hot core alignment it is used only if the core eccentricity is small.</i>	0.0 - 99.9 sec	2.0 sec
FUSION CURRENT 3	Relaxation current <i>During Hot core alignment it is used only if the core eccentricity is small.</i>	0.0 - 29.9 mA	12.5 mA

*Continued on the following page →*

\*As the fiber moving speed = GAP/FUSION CURRENT 1, do not set FUSION CURRENT 1 to 0.0.

<b>Parameter</b>	<b>Function</b>	<b>Range</b>	<b>Default</b>
LEFT MFD	Mode field diameter for left fiber	2.0 - 19.9 $\mu\text{m}$	9.8 $\mu\text{m}$
RIGHT MFD	Mode field diameter for right fiber	2.0 - 19.9 $\mu\text{m}$	9.8 $\mu\text{m}$
SET CENTER POSITION	Sets normal splicing or off-center splicing	200 - 319	255
AOA CURRENT	Arc-on-alignment current Disable by setting to 0.	6.0 - 29.9 mA	0
EARLY PREFUSION	Do prefusion before any alignment	YES/NO	NO (=0)
ALIGN ACCURACY	Accuracy for axis alignment	0.01 - 9.99 $\mu\text{m}$	0.15 $\mu\text{m}$

*The splicing parameters listed on this page will be discussed in greater detail in the section on “Advanced splicing parameters,” pp. 60-1.*

## Pre-defined programs: Programs 01 - 10

As was explained in the section on Basic Operation, the FSU 975 comes with ten pre-defined programs. These programs represent all five splicing processes, and are intended to cover a wide array of splicing needs. It is also recommended that you use them as a base when designing your own programs. With this in mind, the following cards list these programs' parameters. You can also see a program's parameters by following the instructions on page 13 for bringing up the screen-viewer. Keep in mind, though, that these programs are NOT editable. So if you want to make modifications you will have to copy the program to one of the editable slots by following the instructions in the following section.



### Program 01

"NORMAL SM + SM"  
Standard single fiber  
Normal splicing

PREFUSE TIME	0.2 s
PREFUSE CURRENT	10.0 mA
GAP	50.0 μm
OVERLAP	10.0 μm
FUSION TIME 1	0.3 s
FUSION CURRENT 1	10.5 mA
FUSION TIME 2	2.0 s
FUSION CURRENT 2	16.3 mA
FUSION TIME 3	2.0 s
FUSION CURRENT 3	12.5 mA
LEFT MFD	9.8 μm
RIGHT MFD	9.8 μm
SET CENTER POSITION	255
AOA CURRENT	0.0 mA
EARLY PREFUSION	NO
ALIGN ACCURACY	0.15 μm

# P01

### Program 02

"DSF SM + SM"  
Depressed cladding fiber  
Normal splicing

PREFUSE TIME	0.2 s
PREFUSE CURRENT	10.0 mA
GAP	50.0 μm
OVERLAP	8.0 μm
FUSION TIME 1	0.3 s
FUSION CURRENT 1	10.5 mA
FUSION TIME 2	2.0 s
FUSION CURRENT 2	15.0 mA
FUSION TIME 3	2.0 s
FUSION CURRENT 3	12.5 mA
LEFT MFD	9.8 μm
RIGHT MFD	9.8 μm
SET CENTER POSITION	255
AOA CURRENT	0.0 mA
EARLY PREFUSION	NO
ALIGN ACCURACY	0.15 μm

# P02

### Program 03

"TITAN SM + SM"  
Titanium fiber  
Normal splicing

PREFUSE TIME	0.2 s
PREFUSE CURRENT	10.0 mA
GAP	50.0 μm
OVERLAP	8.0 μm
FUSION TIME 1	0.3 s
FUSION CURRENT 1	10.5 mA
FUSION TIME 2	2.0 s
FUSION CURRENT 2	14.0 mA
FUSION TIME 3	2.0 s
FUSION CURRENT 3	13.0 mA
LEFT MFD	9.0 μm
RIGHT MFD	9.0 μm
SET CENTER POSITION	255
AOA CURRENT	6.5 mA
EARLY PREFUSION	YES
ALIGN ACCURACY	0.15 μm

# P03

### Program 04

"NORMAL MM + MM"  
Multimode fiber  
Normal splicing

PREFUSE TIME	0.3 s	FUSION TIME 2	2.0 s
PREFUSE CURRENT	11.5 mA	FUSION CURRENT 2	15.5 mA
GAP	50.0 μm	FUSION TIME 3	1.0 s
OVERLAP	12.0 μm	FUSION CURRENT 3	12.5 mA
FUSION TIME 1	0.3 s	LEFT MFD	9.8 μm
FUSION CURRENT 1	12.0 mA	RIGHT MFD	9.8 μm
		SET CENTER POSITION	255
		AOA CURRENT	0.0 mA
		EARLY PREFUSION	NO
		ALIGN ACCURACY	0.25 μm

# P04

**Program 05**

"ECCENTRIC SM + SM"

Single fiber with eccentric core  
Hot core alignment

MAX ECCENTRICITY	1.0 µm
RTC CURRENT	12.5 mA
ACCEPTABLE OFFSET	0.3 µm
PREFUSE TIME	0.3 s
PREFUSE CURRENT	10.0 mA
GAP	50.0 µm
OVERLAP	8.0 µm
FUSION TIME 1	0.2 s
FUSION CURRENT 1	10.5 mA
FUSION TIME 2	0.3 s
FUSION CURRENT 2	0.0 mA
FUSION TIME 3	3.0 s
FUSION CURRENT 3	16.0 mA
LEFT MFD	9.8 µm
RIGHT MFD	9.8 µm
SET CENTER POSITION	255
AOA CURRENT	0.0 mA
EARLY PREFUSION	NO
ALIGN ACCURACY	0.10 µm

P05

**Program 06**

"ERBIUM + SM MCVD"

Erbium fiber with single fiber  
Mode field matching

INDEX LIMIT	0.4
THRESHOLD TYPE	Difference
LOSS FACTOR	0.35
PREFUSE TIME	0.3 s
PREFUSE CURRENT	10.0 mA
GAP	50.0 µm
OVERLAP	8.0 µm
FUSION TIME 1	0.3 s
FUSION CURRENT 1	10.5 mA
FUSION TIME 2	2.0 s
FUSION CURRENT 2	15.5 mA
FUSION TIME 3	0.5 s
FUSION CURRENT 3	12.0 mA
LEFT MFD	7.5 µm
RIGHT MFD	8.5 µm
SET CENTER POSITION	255
AOA CURRENT	6.5 mA
EARLY PREFUSION	NO
ALIGN ACCURACY	0.10 µm

P06

**Program 07**

"ERBIUM + DSF OVD"

Erbium with dispersion shifted  
Mode field matching

INDEX LIMIT	2.6
THRESHOLD TYPE	Higher start
LOSS FACTOR	0.35
PREFUSE TIME	0.3 s
PREFUSE CURRENT	10.0 mA
GAP	50.0 µm
OVERLAP	4.0 µm
FUSION TIME 1	0.3 s
FUSION CURRENT 1	10.5 mA
FUSION TIME 2	1.5 s
FUSION CURRENT 2	15.0 mA
FUSION TIME 3	0.5 s
FUSION CURRENT 3	12.0 mA
LEFT MFD	7.5 µm
RIGHT MFD	9.0 µm
SET CENTER POSITION	255
AOA CURRENT	6.5 mA
EARLY PREFUSION	YES
ALIGN ACCURACY	0.10 µm

P07

**Program 08**

"SM ATTENUATOR"

Standard single fiber  
Attenuator making

DESIRED ATTENUAT.	15 dB
OFFSET ADJUSTMENT	0.0 µm
ECF FACTOR	1.3
PREFUSE TIME	0.3 s
PREFUSE CURRENT	10.0 mA
GAP	50.0 µm
OVERLAP	4.0 µm
FUSION TIME 1	0.3 s
FUSION CURRENT 1	10.0 mA
FUSION TIME 2	0.6 s
FUSION CURRENT 2	12.0 mA
FUSION TIME 3	0.3 s
FUSION CURRENT 3	9.0 mA
LEFT MFD	9.8 µm
RIGHT MFD	9.8 µm
SET CENTER POSITION	255
AOA CURRENT	6.5 mA
EARLY PREFUSION	NO
ALIGN ACCURACY	0.10 µm

P08

**Program 09**

"SM FIBER LENS"

Standard single fiber  
Pulling or tapering

PULL 1	YES
PULL 2	YES
PULL 3	YES
PREFUSE TIME	0.3 s
PREFUSE CURRENT	10.0 mA
GAP	0.0 µm
OVERLAP	0.0 µm
FUSION TIME 1	9.0 s
FUSION CURRENT 1	15.0 mA
FUSION TIME 2	7.0 s
FUSION CURRENT 2	12.0 mA
FUSION TIME 3	2.0 s
FUSION CURRENT 3	7.0 mA
LEFT MFD	9.8 µm
RIGHT MFD	9.8 µm
SET CENTER POSITION	255
AOA CURRENT	0.0 mA
EARLY PREFUSION	NO
ALIGN ACCURACY	0.15 µm

P09

**Program 10**

"SM 80 UM MICRON"

Standard single fiber  
Normal splicing

PREFUSE TIME	0.2 s
PREFUSE CURRENT	8.0 mA
GAP	40.0 µm
OVERLAP	4.0 µm
FUSION TIME 1	0.3 s
FUSION CURRENT 1	8.5 mA
FUSION TIME 2	2.0 s
FUSION CURRENT 2	12.0 mA
FUSION TIME 3	0.0 s
FUSION CURRENT 3	0.0 mA
LEFT MFD	8.5 µm
RIGHT MFD	8.5 µm
SET CENTER POSITION	255
AOA CURRENT	0.0 mA
EARLY PREFUSION	NO
ALIGN ACCURACY	0.10 µm

P10

# Program editing: Programs 11 - 50

One of the most important features of Advanced Operation is that you yourself can design your own splicing programs. The FSU 975 comes with 40 slots for user-defined splicing programs, and the following ten steps outline how you can fill them. Note that program editing with the FSU 975 is organized serially, meaning that to reach a later step you must pass through the ones preceding it. (eg. You cannot directly jump to Step 5, but rather must first go through Steps 1-4.)

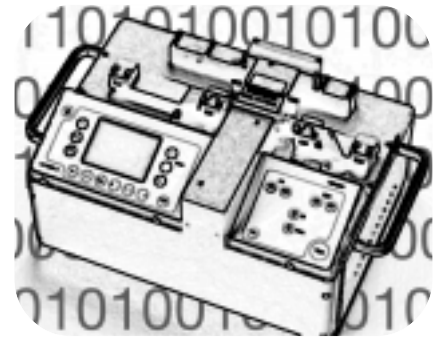

1 Choose a program to edit.....	40
2 Enter editing mode .....	41
3 Pass through security .....	41
4 Use another program as a base .....	42
5 Set or change security .....	43
6 Name or re-name the program .....	44
7 Change the fiber type and splicing process .....	45
8 Edit control parameters .....	46
9 Edit splicing parameters .....	48
10 Re-edit program .....	49

## 1 Choose a program to edit

To choose a program to edit you follow the program selection process. You start by pressing ENTER, which brings up the question “New Program?” You then answer **Yes** and follow the instructions listed on pages 14-15, steps A - C.

If you have already selected the program you want to edit, you can jump to step 2.

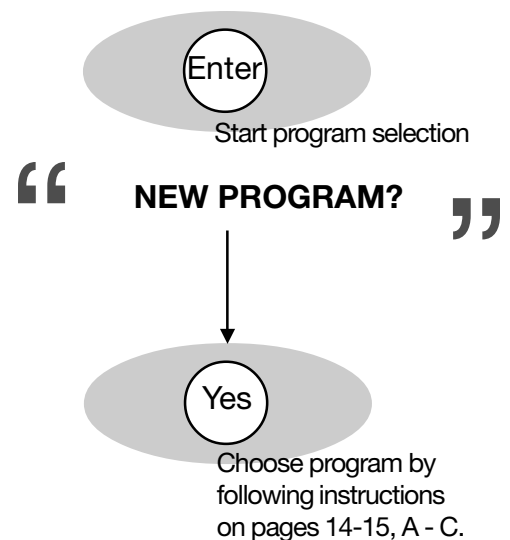

You should note that nearly all of the splicer messages listed during program editing appear in the *message field*. From the point you press ENTER in the first step, the *mode field* is devoted to showing the program you are editing. The adjacent figure shows an example where the program we are editing is Program number 26, MODIFICATION 1.

**MODIFICATION 1 P26  
NEW PROGRAM?**

## 2 Enter editing mode

Regardless of whether you have just gone through the program selection procedure, or are starting program editing here, you press ENTER to enter editing mode. (It is equivalent to step D in the program selection procedure.) The splicer will then ask you (possibly for the second time) if you want to change program.

If the program listed in the *mode field* is indeed the one you want to edit, you should answer **No**, and reject program selection.

The splicer will then ask if you want to edit parameters, and you confirm this by pressing **Yes**. At this point you will enter program editing mode.

If you answer No, you will exit both program editing and program selection, and will return to splicing mode.

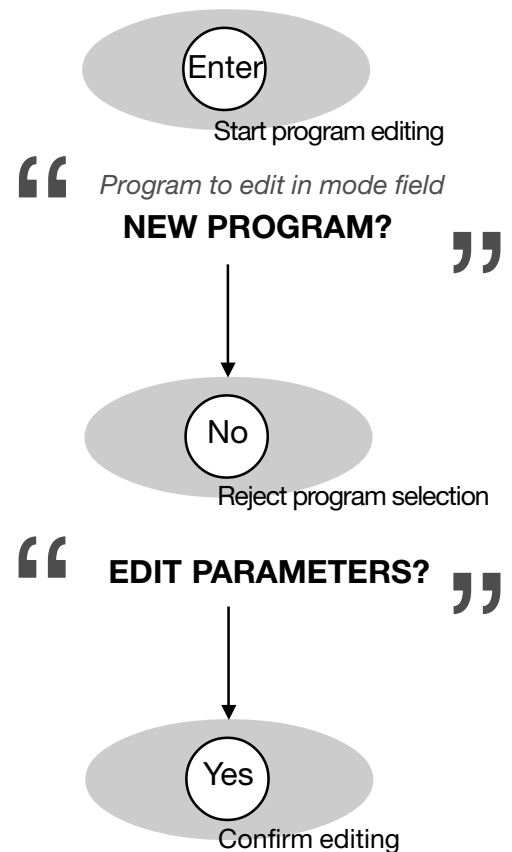

## 3 Pass through security

If the program you have selected in step 1 is classified as an "Open" program, you will not be asked to enter a key number (a security code).

If, however, the selected program is classified as either "Read only" or "Confidential," you must enter the security code at this point using the number buttons. Remember that the number buttons are organized such that the first button (from the left) corresponds to the first number of the code, the second button to the second number, and the third to the third.

You will then have to confirm the code by pressing ENTER. If you have entered the wrong code, you will be aborted from program editing.

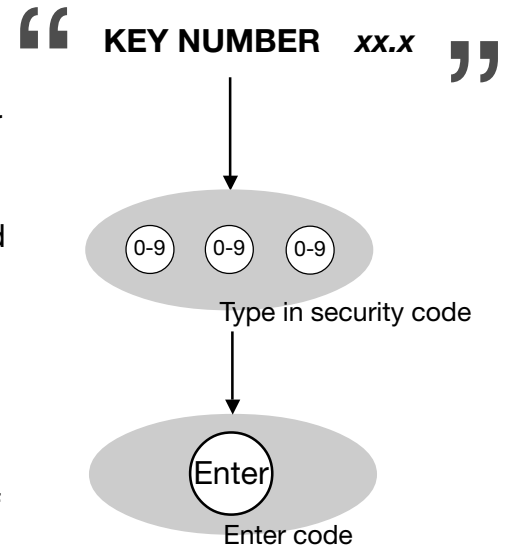

## 4 Use another program as a base

As has been recommended earlier, it is helpful to use another program as a base when designing your own. If you want to do so, and copy the parameters of another program into the slots of your new program, you should press **Yes** at this point. If you do not want to copy parameters from another program--because you are editing again a program you designed previously, for example--you should press No and go onto step 5 on the following page.

The splicer will then ask in the *message field* which program you want to copy ("Copy Source Pyy"), and you must enter the number of the program you want to copy by using the first two number buttons (from the left). Let's say that we chose to copy the parameters from Program 08. In that case you would enter a "0" with the first number button and an "8" with the second.

You enter the choice of source program by pressing ENTER.

The splicer will then ask you to confirm that you want to replace the parameters in the program selected in step 1 with those of the source program just selected. This confirmation is very similar to what computers do when they ask you if you are sure you want to delete a certain file, because copying the source program's parameters will erase whatever parameters were there beforehand.

To confirm your desire to copy the source program, press **Yes**. If you press No, then the copying will be cancelled.

As a last precaution, the splicer will then ask for the security code for the source program if the source program is classified as "Confidential". This is to ensure that no one has access to programs they shouldn't just by copying them to a new slot. To give a source program's security code, you follow the same procedure as in step 3.

“ COPY PARAMETERS? ”

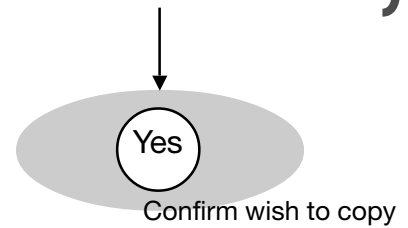

“ COPY SOURCE Pyy ”

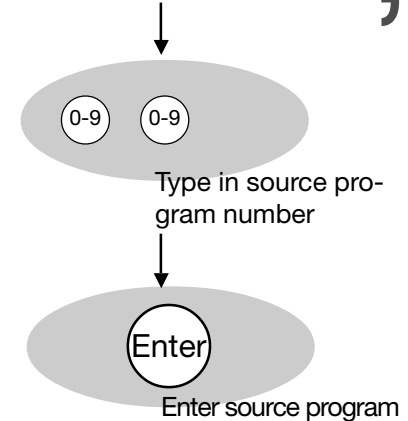

“ OVERWRITE Pxx ? ”

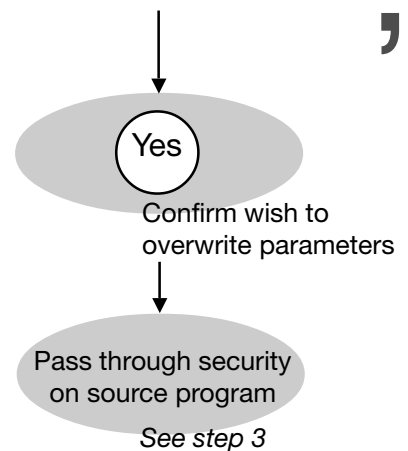

## 5 Set or change security

Before you start creating or editing your program it is important to stop and determine what type of security you want on it. If, for example, you just copied the parameters out of one of the pre-defined programs, the security is classified as "Open," meaning that anyone could come along after you and change the parameters again. If you don't want this to happen, you can protect your program by making it either "Read only" or "Confidential."

**A** The first step in changing security is to change the security code. If you are intending that the program have a security type other than "Open," it is necessary to have a code known only by those who need access to the program's parameters. Remember that the security code imported from pre-defined programs is "00.0," and is printed in the manual. To confirm that you want to change the security code, press **Yes**.

The message field will then open up for you to enter a new code by displaying "New code xx.x." You can then type in your new code using the number buttons. As always with security codes, it is best to pick something memorable but not too obvious.

You enter your new security code by pressing ENTER.

**B** It is now time to change the security type--to choose whether the program will be classified as "Open," "Read only" or "Confidential." The splicer will ask in the *message field* "Change security type"?, and to do so, press **Yes**. If you press No, you go to step 6.

The splicer will then present each possibility one by one. It will first read "Open?!" in the message field, and if you do not want the program to be classified as Open you press **No**. It will then offer "Read Only?" as an alternative, and after that "Confidential?" If you press **No** when it reads "Confidential?" "Open?!" will come up again.

In short, you scroll through this list with the **No** button until the security type you want is shown in the *message field*, and then press **Yes**.

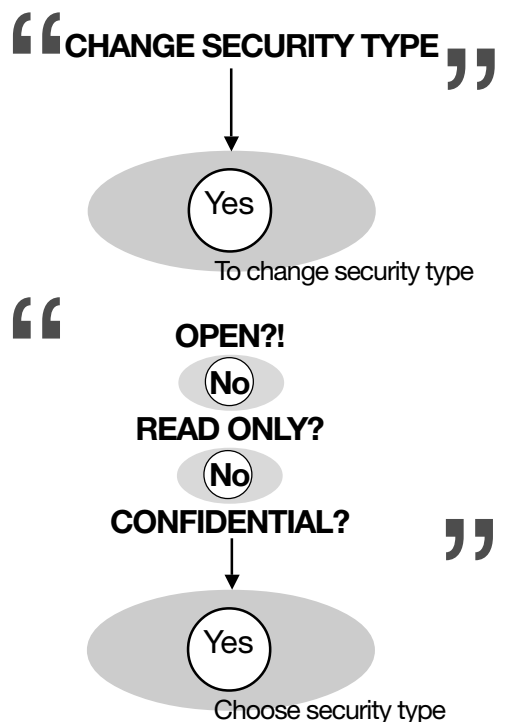
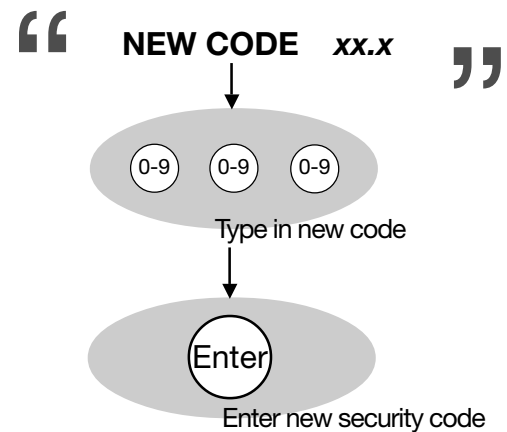
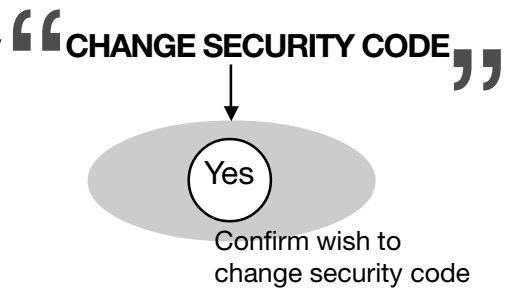
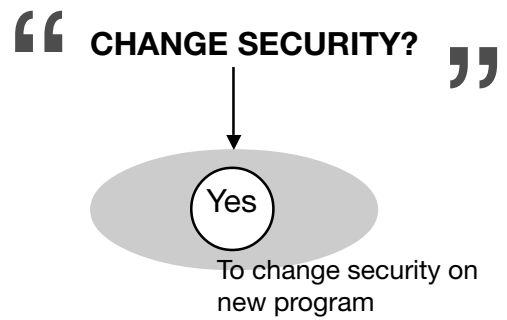

To orient yourself within the splicing program structure, you should take note that the step we just completed was to change two of the general parameters listed on page 34: KEY NUMBER and SECURITY TYPE. The other three general parameters (PROGRAM NAME, FIBER PROCESS, and FIBER TYPE) are changed in the following steps, steps 6 and 7.

### General parameters

The general parameters h

Parameter
PROGRAM NAME

## 6 Name or re-name the program

The next step is to name--or re-name, in the case of simple editing--the splicing program. As explained above, the program name will be stored, with the security code and security type, amongst the general program parameters. The splicer will ask in the *message field*, "Change program name?," and to do so, you press **Yes**.

Entering text on the FSU 975 is controlled by the arrow buttons, according to the adjacent description. You can also use a method of quick character selection, which is described on page 52 to facilitate the process. Regardless how you enter the name, it should be no more than 16 characters long, and sufficiently specific that you will recognize it quickly and easily.

When you have successfully typed in the new program name, you press ENTER to save it.

“CHANGE PROGRAM NAME?”

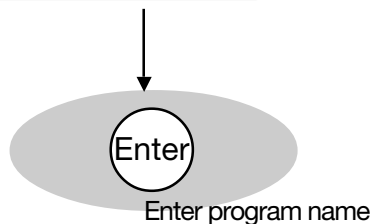
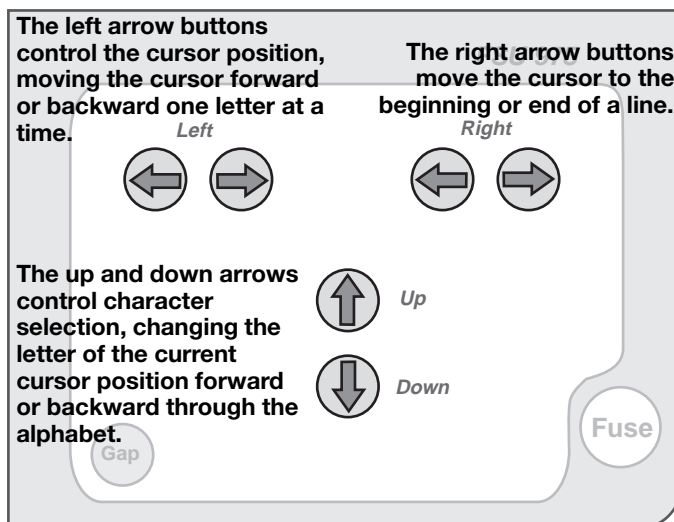
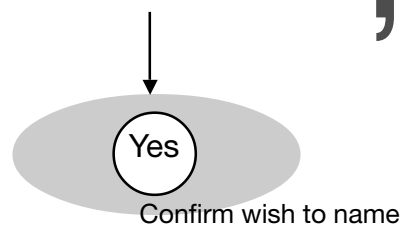

## 7 Change fiber type and splicing process

At this point the splicer will ask if you want to change fiber type and/or splicing process. If you have copied over a source program (step 4) for which you only want to modify a few parameters, you may be able to skip this step. However, this is also a chance to verify that the right fiber type and splicing process are specified. To see these parameters you can press VIEW and bring up the screen-viewer. The fiber type and splicing process will be highlighted.

If you wish to change fiber type and/or splicing process, press **Yes**.

If you do not, press No and go on to Step 8.

**A** The splicer will start with fiber type and ask you whether you want to change it by displaying “Change fiber type?” in the *message field*. If you are interested in changing the fiber type, press **Yes**.

If you are only interested in changing the splicing process, press No, and continue reading at “B” on page 46.

The splicer will then present you the options for fiber type in the same format as it did with security types: Each fiber type will successively be shown in the message field, while you scroll through them by pressing **No**.

When the fiber type you want is shown in the message field, you press **Yes**.

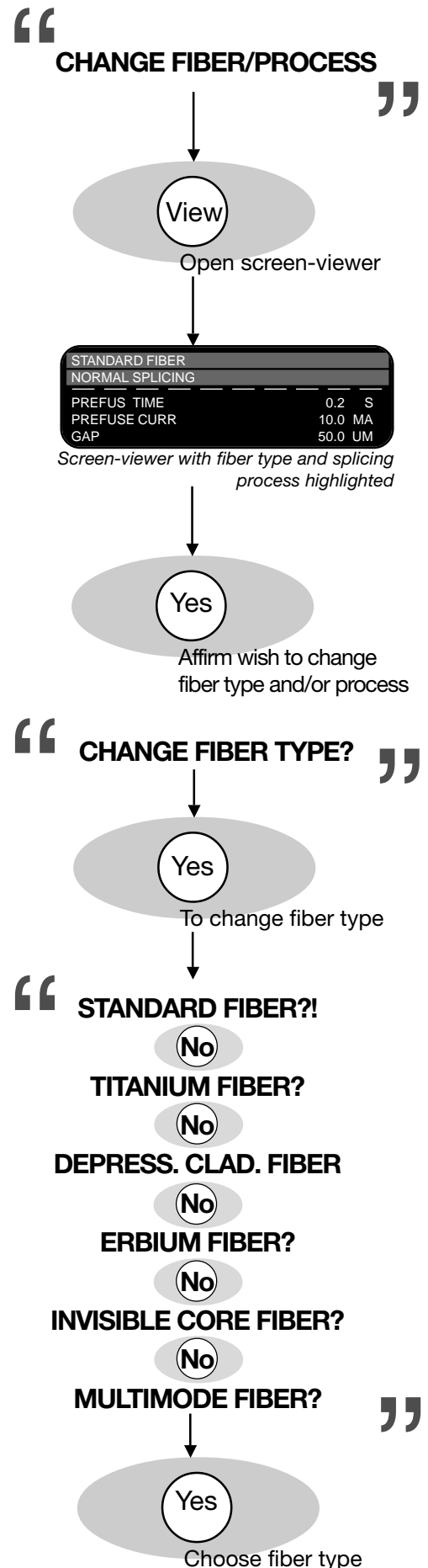

**B** The same procedure is then repeated in the case of splicing process. The splicer will ask “Change process type?”, and you respond by pressing **Yes** if you do indeed want to change it.

If you only wanted to change the fiber type, and do not want to change the splicing process, you can press No and go on to step 8.

If you press Yes, the list of splicing processes will present itself one by one in the message field, while you scroll through the list by pressing **No**. If by chance you miss the splicing process you want you can get it back in the monitor by pushing **No** until the list wraps around (eg. If you press No after “Pulling or tapering?” you will next see “Normal splicing!?” again).

When the splicing process you want is in the message field you should press **Yes**.

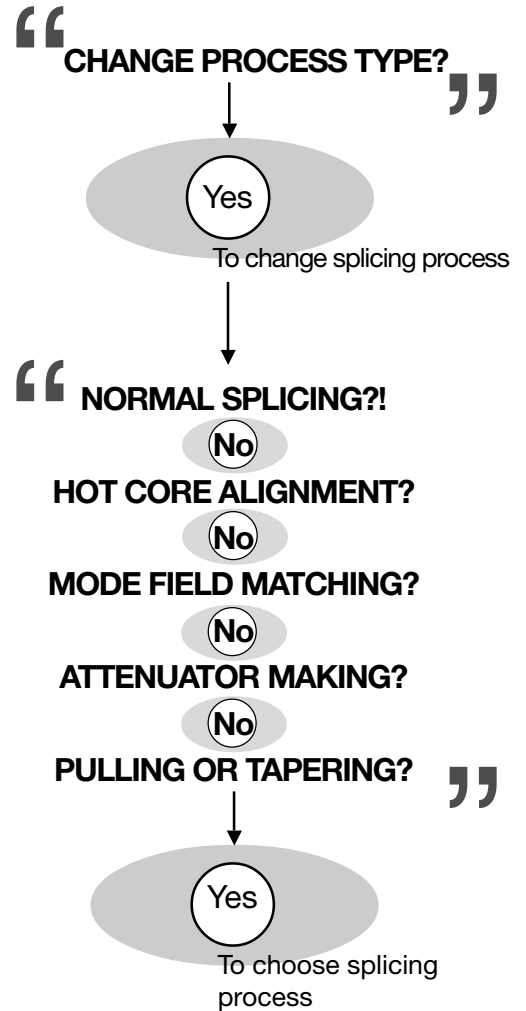

## 8 Edit control parameters

*For a full list of control parameters, see p. 35.*

This step only applies if you are editing a program that uses a splicing process with control parameters (eg. if the splicing process is NORMAL SPLICING, the splicer will not ask you whether you want to edit control parameters). In the cases that there are control parameters, the splicer will ask you “Edit control paras?.” You have the option at this point of pressing the VIEW button and bringing up the screen-viewer to see what values the parameters have. The screen-viewer will come up with the fiber type and splicing process highlighted as in the picture on page 45.

If you decide that do want to edit the control parameters, press **Yes**.

If you press No, you go on to step 9.

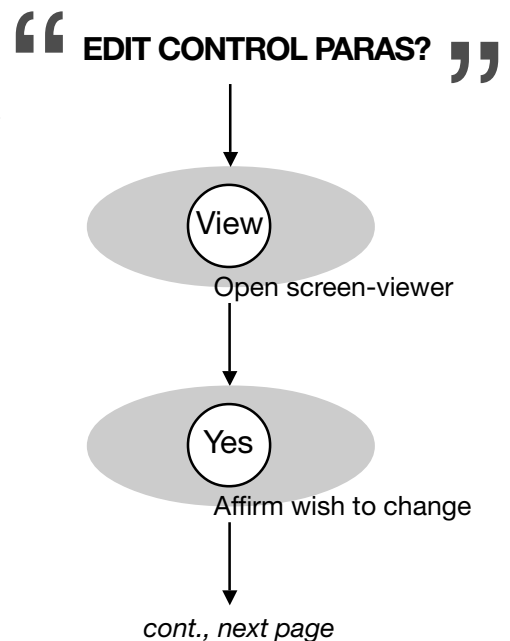

As all splicing processes have different control parameters (see pages 28-33), we will take the control parameters for mode field matching as an example. The range for possible values for mode field matching control parameters is listed on p. 35.

In the example shown to the right, the values you can change are highlighted. However, they will not be highlighted in the *message field* of the splicer.

**Step-by-step:**

In the adjacent example, you will first see “Index limit” with its present value, which you can change by pressing the first two numerical buttons (from the left) until the desired value is displayed. You then press ENTER.

The next control parameter is Threshold type, which will be presented to you in the form of a list of all the possible values. You scroll through this list by pressing No, until the desired value is displayed. You then press **Yes**.

The last mode field matching parameter is LOSS FACTOR, which will appear in the *message field* along with its present value. You enter a new value, if desired, with the numerical buttons, and then press ENTER.

**In short:**

Each of the parameters appears successively in the *message field*, and you first change its value with either the number buttons, in the case of quantitative parameters, or Yes and No buttons, in the case of a binary (On/Off) parameters, and then press ENTER to save the new value. The only exceptions are parameters, such as Threshold type test, which have several distinct, non-numerical values. These parameters will present themselves as fiber type and splicing process do.

You should note that the procedure for editing control parameters has a logic that applies to all parameter editing, so once you are used to the logic for control parameter editing, you will know how to change any FSU 975 parameter (see also p. 50 for a review of this logic).

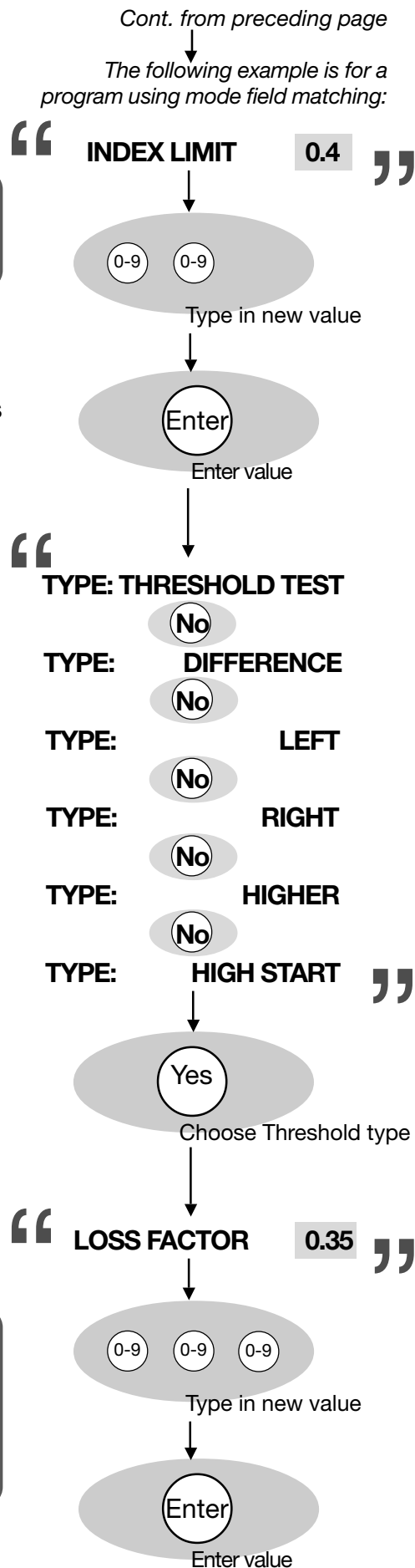

## 9 Edit splicing parameters

For a full list of splicing parameters, see pp. 36-7.

If you have just edited control parameters, this step will be very straight-forward. First, the splicer will ask you “Edit splicing paras?,” and once again you have the option of pressing the VIEW button to bring up the screen-viewer. If opened, the screen-viewer will come up with the splicing parameters highlighted.

Next, if you want to edit the splicing parameters, press **Yes**. If you press No, you go on to step 10.

In the example shown to the right, the values you can change are highlighted. However, they will not be highlighted in the *message field* of the splicer.

### Step-by-step:

After you press Yes, the first splicing parameter, PREFUSE TIME, will appear in the message field along with its current value. If you want to change it, you use the number buttons to change it. When you have the desired value for the parameter, press ENTER.

The splicer will then display the second parameter, PREFUSE CURR, and its value, which you can also change using the number buttons. Save the new value by pressing ENTER.

The rest of the parameters will follow this exact same procedure, with the exception of EARLY PREFUSION. For an example of how to deal with such binary parameters, see the parameter editing summary on page 50.

**Splicing parameter editing is complete when the value for the last parameter has been entered.**

### In short:

Each of the parameters appears successively in the *message field*, and you first change its value with either the number buttons, in the case of quantitative parameters, or Yes and No buttons, in the case of a binary (On/Off) parameters, and then press ENTER to save the new value.

For those of you who skipped over control parameter editing, we want to once again point out that the procedure for editing splicing parameters has a logic that applies to all parameter editing. So once you are used to the logic for splicing parameter editing, you will know how to change any FSU 975 parameter (see also p. 50 for a review of this logic).

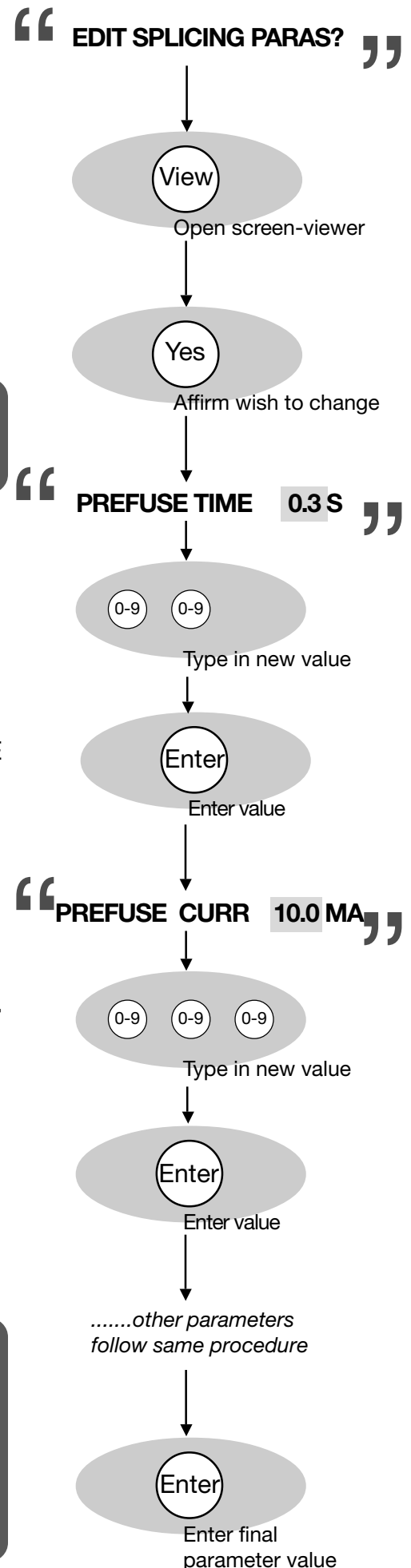

## 10 Re-edit program

At this point you have finished editing the splicing program. The splicer gives you a chance to go back, however, and make adjustments you might have missed the first time round.

If you are not sure about whether you are satisfied with the current version of the program, you should press VIEW and bring up the screen-viewer. The screen-viewer will give you a list of all parameters (control and splicing) and their values.

If you are satisfied with the program, press (No) and end the editing session. The splicer will tell you it is "Updating parameters..." and then return to splicing mode.

If you press Yes, you will return to step 5 (p. 43).

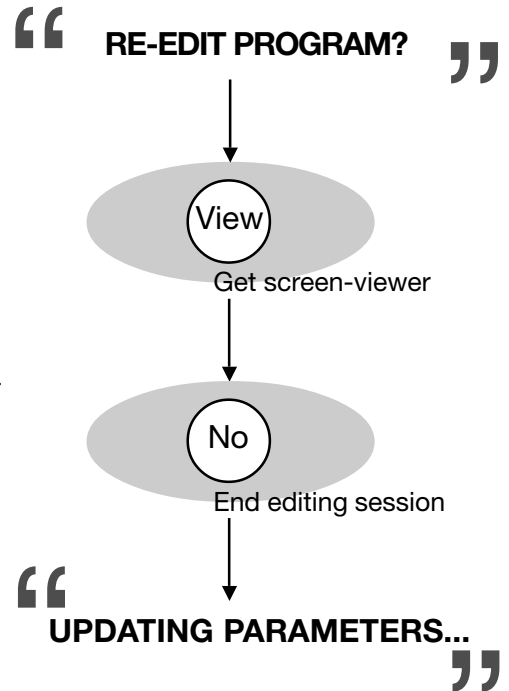

Once you have gone through the program editing sequence once or twice, you will probably no longer need the step-by-step guide presented on these pages. Nevertheless, you may still want some reference for locating specific parameters and keeping tabs on where you are in the overall editing tree. If this is the case, you can look at the program editing flow chart in Appendix C, pp. 74-5.

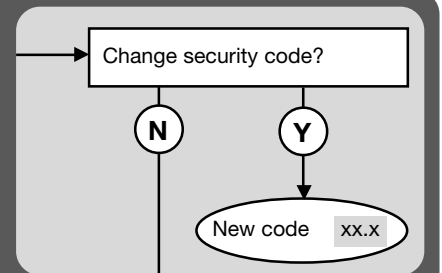

# Parameter editing review

When considered step by step parameter editing can seem interminable; however, there is a basic logic that guides the editing procedure. Once you have become familiar with this logic, parameter editing will go easily and quickly.



## The programming buttons



The ENTER button has two functions:

1. To initialize the editing procedure.
2. To enter new values for the parameters.

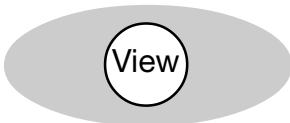

The VIEW button brings up the screen-viewer, so you can check the current values for parameters.

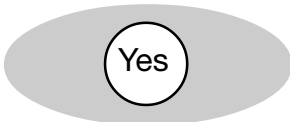

The YES button is used to answer two sorts of questions:

1. In navigation through a procedure, to answer that you want to make the changes involved in the next step.
2. With binary parameter values (see description on the following page), to turn a parameter ON.

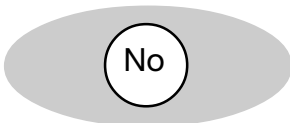

The NO button is used to answer two sorts of questions:

1. In navigation, to answer that you do NOT want to make the changes involved in the next step. It is by pushing the NO button that you accelerate yourself from step to step during the editing procedure.
2. With binary parameter values (see description on the following page), to turn a parameter OFF.

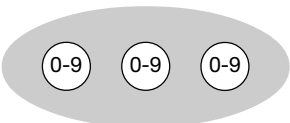

The number buttons are used to enter numerical values for quantitative parameters.

## Navigation through the parameter editing procedure

Navigation during parameter editing occurs by means of Yes/No questions. The editing procedure has been designed in blocks. The steps 1-10 you have just gone through correspond to these blocks. If you notice each of these blocks is prefaced by a Yes/No question. If you answer Yes, you go through the step and carry out the changes it entails. If you answer No, you jump to the next step. This makes it possible to speed up the editing procedure if you know in advance what you want to change.

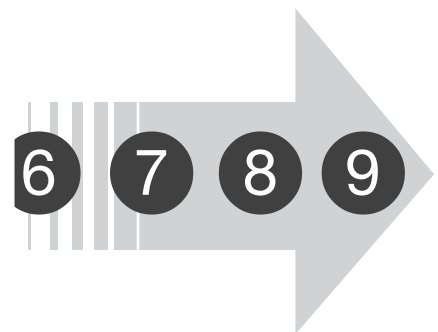

## Types of parameter values

Parameters can be divided according to the kind of values they hold. In the FSU 975 there are three major types of parameter values, each of which involves a slightly different editing procedure.

### 1 Quantitative parameter values

A quantitative parameter value is a number. An example is found in PREFUSE TIME, which we saw edited on page 48. The general procedure is as follows:

- The parameter appears with its current value.
- You can change the value using the number buttons
- You press ENTER to save the new value.

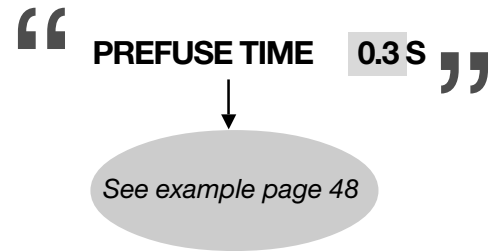

### 2 Binary parameter values

A binary parameter value has two states, usually either ON or OFF. An example of this type of value amongst the splicing parameters is EARLY PREFUSION, which we will take as an example here:

- The parameter name is presented as a question, and a variable region which toggles between Yes and No.
- Press the (No) button to turn the parameter off, and the (Yes) button to turn it back on again.
- Press ENTER to save the value of the parameter.

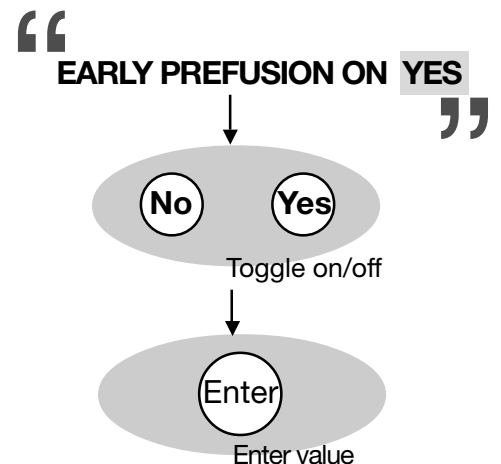

### 3 Parameters with multiple values

There are a few parameters which have multiple, non-numerical values. An example amongst the general parameters is SECURITY TYPE, which we saw edited on page 43. The general procedure is as follows:

- The first possible value for the parameter occurs with a question mark.
- If this is not the value you want, you press (No), at which point the second value appears, again as a question.
- You continue to press (No) and scroll through the list of possible values until the value you want is shown in the message field. At which point you press (Yes) and enter the new value for the parameter.

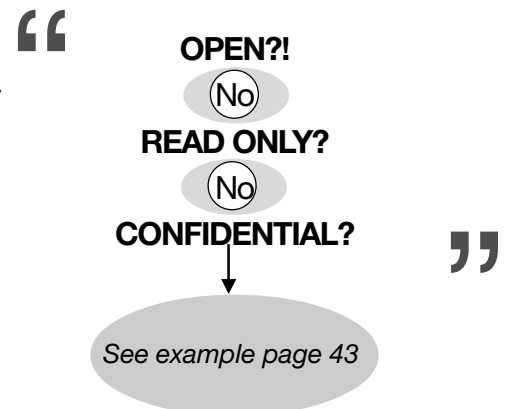

## Special functions

### A Quick character selection

The character selection method described for defining a program name (p. 46) is effective but can be a little slow, so it is advantageous to learn the adjacent shorthand. Quick character selection can not be used in isolation since not all characters are available, but it can facilitate entering information into the splicer.

Do **NOT** press the buttons ON/OFF, ENTER or FUSE when using quick character selection.

Button	Corresponding character
Yes	Y
No	N
0-9 (left)	A
0-9 (middle)	O
0-9 (right)	&
Select	S
+	+
-	-
View	V
Esc	E
Mode	M
Hot image	H
Gap	space

### B Global parameters: Program 00

If you set the program number to 00 (follow instructions on page 14) and enter the key number "975," you gain access to the global parameters, which are the parameters that control the general functioning of the splicer. The organization in sub-groups is repeated by the order of editing you will find in flow chart form in Appendix C.

Parameter	Function	Range	Default
ENGLISH VERSION?	Multiple value parameter for the language of display. Different splicers have different sets of languages.	0 - 12	ENGLISH (=0)
DISPLAY GAP ANGLE*	Stop during alignment to display the view and gap angles.	ON/OFF	OFF (=NO)
ALTITUDE*	For current compensation at altitudes other than sea level.	-2.00 - 8.00 km	0.00 km
MAX GAP ANGLE	If gap angle greater than this parameter's value, a warning is given.	0 - 9.9°	2.0°
MAX VIEW ANGLE	If view angle greater than this parameter's value (because of dust in V-grooves or fiber bending) a warning is given.	0 - 9.9°	0.6°
STOP AT FUSION	If ON, the splicing sequence will be paused after alignment.	ON/OFF	OFF (=NO)

*Continued on the following page →*

\*DISPLAY ANGLES and ALTITUDE will be described in greater detail on pages 54 and 55.

	Parameter	Function	Range	Default
Estimation parameters	LOSS EST. LEV	Gives you the option of deciding in what cases you want the splicer to estimate the splice loss. 0 = Turns off loss estimation 1 = Estimation only when in Automode 2 = Always do loss estimation	0 - 2	2
	SHOW LOSS TO	When the estimated loss exceeds this value the splicer will display "BAD SPLICE."	0.0 - 49.9 dB	2.0 dB
	MACROBENDING	A proportionalizing factor that is used to optimize estimation of loss due to macrobending.	0.0 - 9.9	0.3
Current	RTC CURR LOL	Low limit for RTC current.	0 - 29.9 mA	14.5 mA
	RTC CURR HIL	High limit for RTC current.	0 - 29.9 mA	15.5 mA
CPU settings	SPLICES TOTAL:	The total number of splices made by the splicer: UNEDITABLE.	0 - x	x
	SPLICES:	Splice counter.	0 - x	x
	RESET SPLICES?	Resets splice counter to 0. Should be done every time you replace the electrodes.	YES/NO	NO (=0)
	WAIT TIME	Time of inaction before splicer turns off automatically.	0.0 - 4.9 MN	1.0 MN
	ELECTROD WARNING	Number of splices before splicer warns you that it is time to replace the electrodes.	00 - 99 HS (HS = hundred splices)	20 HS (=2000 splices)
	TURN OFF	You can disable the function by which the splicer turns off automatically by setting to NO.	YES/NO	YES (=1)
	YEAR	The current year.	00 - 99	set in factory
	MONTH	The current month.	00 - 12	set in factory
	DAY	The current day.	00 - 31	set in factory
	HOUR	The current hour.	00 - 24	set in factory
MIN	The current minute.	00 - 59	set in factory	

## DISPLAY GAP ANGLE parameter

If you set the parameter DISPLAY GAP ANGLE to YES, the splicer will stop during fine alignment and show you the gap angles (cleave angles) and view angles (angular deviation of fibers in camera's viewing plane, see also figure below). If you follow the adjacent diagram you see that the splicer first pauses and shows you the view angle offsets, where: L VIEW ANGLE is the view angle offset in the lower view, and R VIEW ANGLE is the view angle offset in the upper view.

You then press the  $\star$  button to see the gap angles, where: L GAP ANGLE is the cleave angle of the left fiber, and R GAP ANGLE is the cleave angle of the right fiber.

By pressing the  $\star$  button again the splicer resumes the splicing procedure.

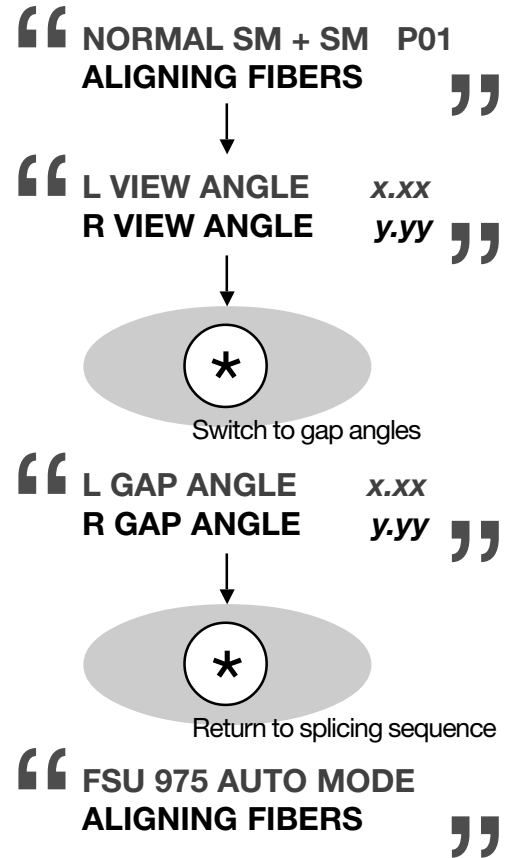

### Definitions of angles

Counter-clockwise angles (eg.  $\alpha_{\text{left}}$  and  $\beta_{\text{left}}$ ) are measured as positive.

Clockwise angles (eg.  $\alpha_{\text{right}}$  and  $\beta_{\text{right}}$ ) are measured as negative.

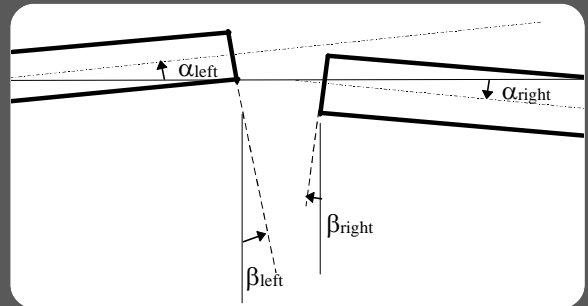

## ALTITUDE parameter

When working at altitudes significantly higher, or lower, than sea level, it is important to adjust the electrode currents to compensate for the decreased, or increased, air density. If you fill in the ALTITUDE parameter with your working altitude in kilometers, the FSU 975 will automatically recalibrate the prefusion current and the three fusion currents to your actual work conditions. The adjacent graph shows such an adjustment for original currents of 10, 12, 14 and 16 mA.

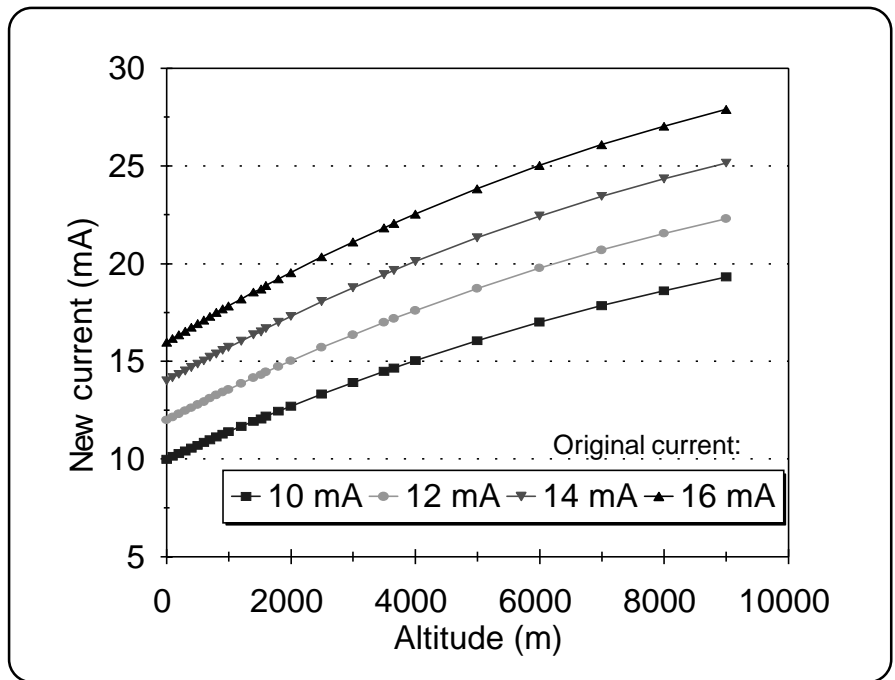

Adjusted currents to compensate for altitude above sea level

If you are using the ALTITUDE parameter, you can view the adjusted currents by pressing ESC before splicing.

The information will be displayed in the *mode field* according to the following abbreviations:

CU0 = PREFUSE CURRENT    P = Current without compensation  
 CU1 = FUSION CURRENT 1    F = Current with compensation  
 CU2 = FUSION CURRENT 2  
 CU3 = FUSION CURRENT 3

And in the *message field* you will see the current setting for the ALTITUDE parameter.

In this example, the ALTITUDE is set for 1 km above sea level, the adjusted prefusion current is 11.2 mA, and the adjusted fusion current 1 is 11.7 mA.

To switch from one current to the next, you successively press ESC. So to get from the information for FUSION CURRENT 1 to FUSION CURRENT 2, press ESC, and from FUSION CURRENT 2 to 3, you press ESC again.

When you are done viewing the adjusted currents, you can press FUSE and continue with the splicing sequence.

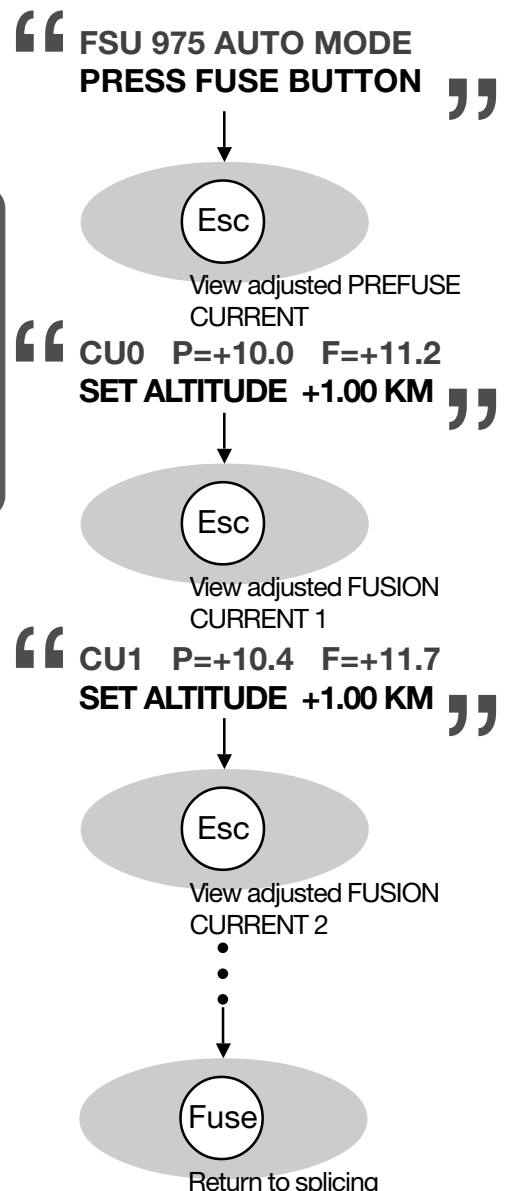

## C Service functions: #-button

If you press the #-button while in splicing mode you gain access to yet another group of operations and parameters. The following section outlines them in the order they come up during editing. However, if you want a more precise overview of the organization of these parameters, see the flow chart in Appendix C.

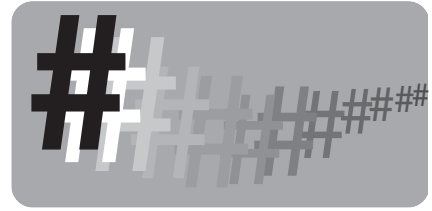

### Current test for hot core alignment: CURRENT TEST?

If you have chosen a program with hot core alignment as its process, the first question that will come up when you press the (#) button is whether you want to run the current test. The current test is used to set the RTC CURRENT parameter, which is described on page 29. The following outlines the procedure you must follow if you want to run the current test and store the resulting value in a hot core alignment program.

1 Choose a program that uses the hot core alignment process. Note that, though you can run the current test with the pre-defined program 05, the resulting value can not be stored in it, so it is best to copy it to another slot by following the instructions on page 42.

ECCENTRIC TEST	
HOT CORE ALIGNMENT	
MAX ECCENTRICITY	1.0 UM
RTC CURRENT	12.5 MA
ACCEPTABLE OFFSET	0.3 UM

Example of a program with hot core alignment in the screen-viewer. The parameter values have been copied from P05 into a new slot and the program renamed.

2 Press the (#) button.



To access current test

3 Press the (Yes) button to say you want to run the current test. You will subsequently have to answer No three times, in order to reject the other operations available via the #-button--namely "Clean electrodes?" "Splicelist handling?" and "Enter service mode?"

“ CURRENT TEST? ”

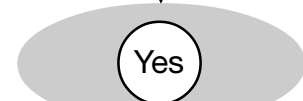

Choose current test



Reject other operations

4 The splicer will then instruct you that in order to start the current test, you must press the FUSE button.

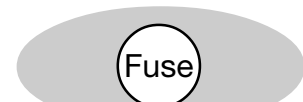

Run current test

5 The splicer will then run the current test, store the value for RTC CURRENT, and carry out the splicing sequence to its completion. If the splicer can not splice the tested fibers (because they became damaged during the test), it will display the fault message "REPLACE FIBERS," and you will have to replace the fibers before splicing. If you run the test using Program 05, the splicer can not save a value for RTC CURRENT and will display "CHANGES NOT SAVED."

“ TESTING CURRENT... ”

“ SPLICING... ”

## Electrode cleaning program: CLEAN ELECTRODES?

If you press the (#) button, and you do not have a hot core alignment program in memory, the first question will be asked is whether you want to “Clean electrodes?”. This is something that should be done every time you brush off or replace the electrodes, and is a recommended measure after every twenty splices. If you want to run the cleaning program press (Yes). To then start the cleaning program, press FUSE. To repeat the program (which is recommended), press FUSE again when the program ends. When done cleaning the electrodes, restart the splicer by pressing ON/OFF twice.

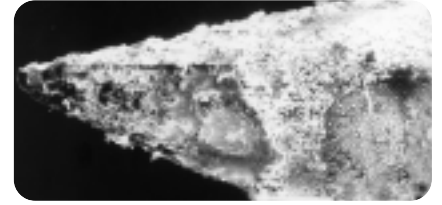

Magnified electrode tip with deposits

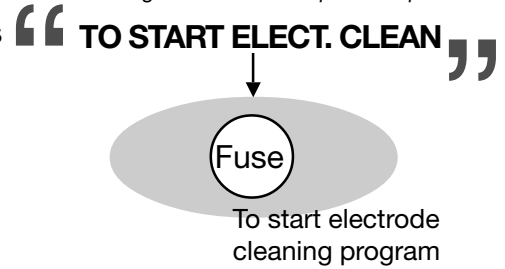

## Splice-list handling

If you press the (#) button, and reply No to the question of whether you want to clean the electrodes, you will gain access to splice-list handling. The splice-list handling procedure occurs in three stages.

### 1 Turn on splice-list handling

You first must turn splice-list handling on by turning on the binary parameter SPLICE LIST:

#-button > “Clean electrodes?” > NO > “Splicelist handling?” > YES > “Change list On/Off” > YES > “Splice list On.” If necessary, press Yes again, so the parameter reads “Splice list On Yes.”

Then press ENTER.

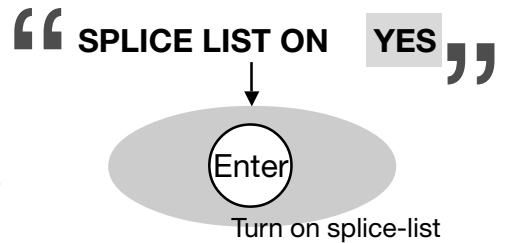

The splicer will then give you the opportunity of setting three organizational parameters by asking “Change list codes?”

If you say (Yes), you will have a chance to specify codes that can be used to organize your splicing data.

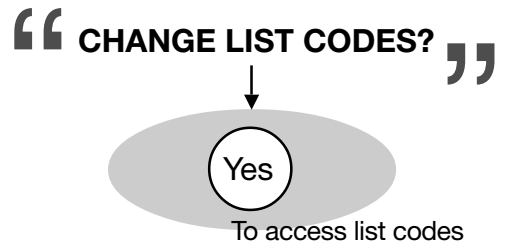

OPERATOR NBR is intended to specify who it is that is creating the splicing data. It can be changed during data collection, so that operators can be compared. You must assign the numbers yourself.

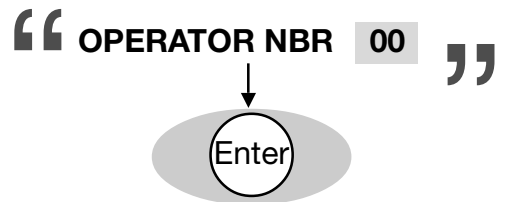

LIST CODE 1 is the first two entirely open areas where you can tag data with additional information that might be important for later analysis. An example might be if you want to have a set of codes for different splicing sites.

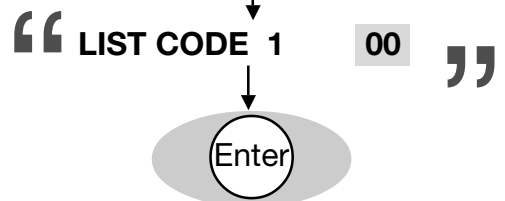

LIST CODE 2 is the second of the two user-definable data tags. Remember that the coding system is your own, and you can return to this parameter during data collection and change its value.

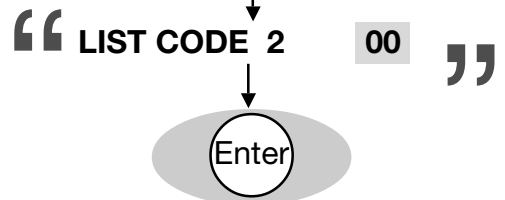

## 2 Collect data

The next step is to collect the splicing data that will form the content of your splice-list. If you have chosen to make use of the operator number and list codes, be sure to be consistent and change their values throughout the data collection stage.

You can collect data for up to 50-60 splices, and it need not be all in one splicing session or on one day. However long it takes, though, you must turn off and on again the splicer before printing the data out.

If at some point, you make a splice you are not happy with, you can delete it by following the steps listed below for printing out a splicelist, but answering "No" when asked whether you want to print out the list. The splicer will then ask if you want to SKIP LAST SPLICE. To do so, press **Yes**.

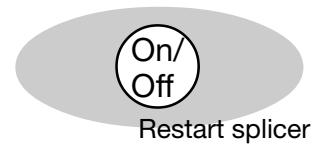
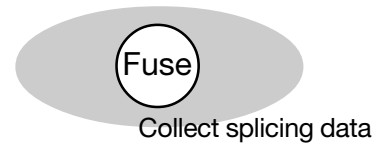

## 3 Print out splice list

You can connect a printer to the splicer via the RS 232 connector (see technical data, p. 70), and the splicer will send the data to it in the form of a spreadsheet. The command that effectuates this process is PRINT SPLICELIST?:

#-button > "Clean electrodes?" > "Splicelist handling?" > YES >  
 "Change list On/Off" > NO > "Change list codes?" > NO >  
 "Print splicelist?"

At this point you can press **Yes** to print out the splice-list.

The splicer will then ask you if you want to "Clear splicelist?" As you can clear a splice-list ONLY when you print it out, you should seriously consider clearing it once you have a good print-out. You press **Yes** to clear the splice-list, making it possible for you to collect new data points.

“ SKIP LAST SPLICE? ”

“ PRINT SPLICELIST? ”

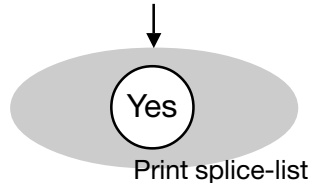

“ PRINTING..... ”

“ CLEAR SPLICELIST? ”

### Reading your splice-list

Splice-lists are organized according to the adjacent diagram.

SPLICE NUMBER	DATE	TIME	MODE / TYPE	LOSS DB	OPERATOR NUMBER	Fiber type	
						CODE 1	CODE 2
01	1999-MAR-14	16:43	M,SD	0.03	12	04	05
02	1999-MAR-14	17:02	A,SD	0.02	12	04	05
03	1999-MAR-15	10:33	M,SD	0.08	10	04	06
04	1999-MAR-15	11:26	M,SD	0.05	10	03	06

### Service mode: ENTER SERVICE MODE?

At various points within the tree of operations under the **#** button, there is an opportunity to pass into service mode: "Enter service mode?" This is intended for authorized service personnel only, so you should always just press **No**.

“ ENTER SERVICE MODE? ”

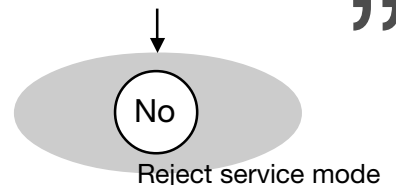

## D Advanced hot image analysis

On pages 21-22 we talked about hot images and hot image analysis. In short, after splicing the FSU 975 automatically calculates a splice loss estimation and makes available two hot images. To see analysis of these hot images, press HOT IMAGE when one of the live images is on the screen. The hot image that comes up will indicate which of the two images it is---here, "1st Image."

To do advanced hot image analysis, press ENTER.

This will bring up the first of the three levels of advanced hot images. The first includes light intensity curves, which can be used to determine the type of fiber being spliced. We have seen them earlier in the section on fiber types on pages 26-7. The "1ST IMAGE" indicates that it is the first of the two hot images taken during the splicing sequence.

Press ENTER to go to the next level of hot image analysis.

The next level of analysis includes three sets of graphs:

- (A) On the far left are two graphs showing the hot fiber index profiles (light intensity profiles) from the top (top graph) and the bottom (bottom graph).
  - (B) In the center are found two graphs that show the core deformations (dotted line) and the base line tilting (solid line) at a magnification of 15x, measured both longitudinally (top) and transversally (bottom).
  - (C) On the far right are two graphs that measure the core diameter as seen from the top and bottom.
- Press VIEW to access the final level of analysis.

The final level of advanced hot image analysis are three-dimensional light intensity curves. The scale is 20  $\mu\text{m}$  between ticks along the longitudinal axis of the fiber and 15  $\mu\text{m}$  between ticks along the transversal axis of the fiber.

Press ESC when you want to exit from advanced hot image analysis.

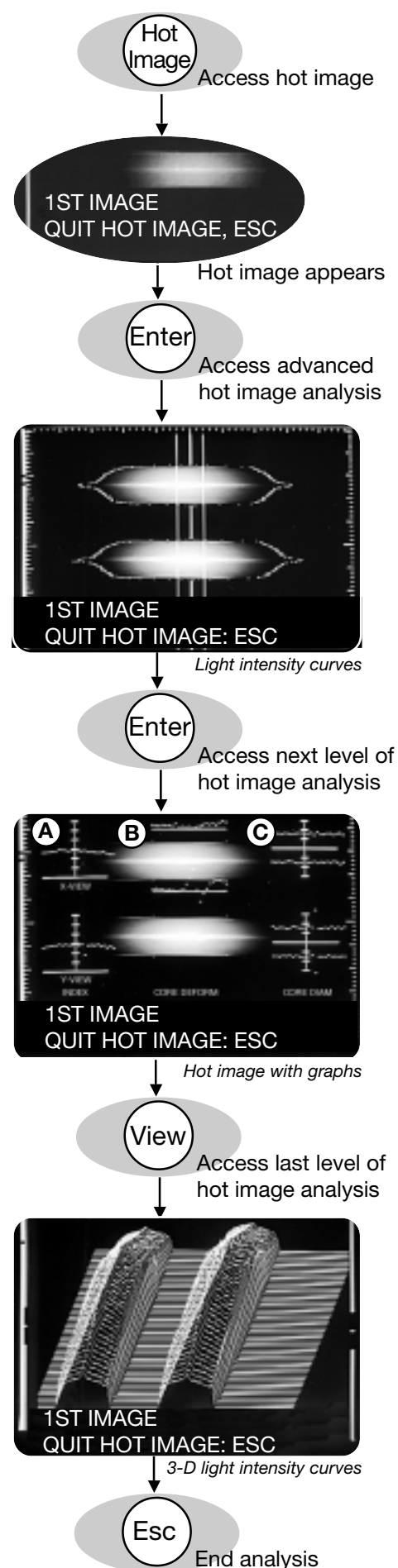

## E Advanced splicing parameters

### Mode field diameters: LEFT MFD and RIGHT MFD

In order to obtain good splice loss estimation it is important to correctly set the mode field diameters for your fibers. The mode field diameters are listed in the specifications for fibers, and the adjacent table gives some representational values. Nevertheless, if possible, it is also a good idea to test your fibers by comparing measured and estimated splice losses over a series of splices.

Fiber Type	Wavelength (nm)					
	488	633	850	980/1060	1300	1550
Single mode	3.7	4.3	5.7	6.6	9.3	10.5
High NA Single mode	-	3.3	4.3	5.3	6.6	7.8
Dispersion Shifted	-	-	-	-	-	8.1

### Centering in monitor: SET CENTER POSITION

The SET CENTER POSITION parameter allows you define what the splicer considers the middle of the monitor. Generally speaking you want to leave it at 255, which represents the number of pixels from the left edge to the center of the monitor. However, with certain types of fibers (eg. carbon coated fibers) it might be advantageous to offset the center point, and thus line up the fibers unequally with relation to the arc.

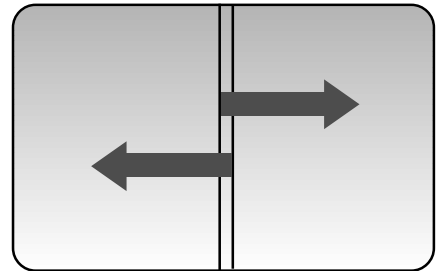

### Arc-on alignment: AOA CURRENT

At arc ignition an electromagnetic field is established that exerts force on the fibers, bending them out of alignment. After initial ignition, the force disappears, and the fibers should come back into place. However, if the V-grooves or the fibers themselves are dirty, they probably won't be able to come back to their original alignment. Additionally, carbon coated fibers and fibers with small core size are pulled to a significantly different degree than other fiber types (see adjacent picture), so with these fibers, it is particularly likely that the fibers will lose their alignment at arc ignition.

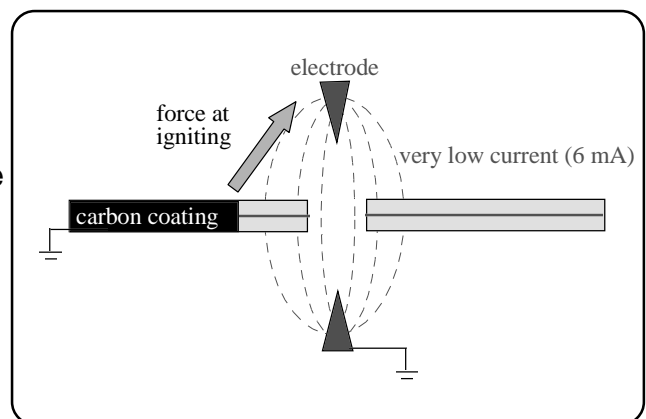

*Increased force because of the conductivity of carbon coating*

To compensate for this problem, the FSU 975 is equipped with the option of setting a low current that can be ignited during fine alignment. This ensures that the alignment is done according to the position that the fibers will be in during splicing. The default value of the AOA CURRENT parameter is 6.5 mA, and it is important not to deviate too far from the default value. Too high of a current will lead to matchsticking. Too low of a current can permanently damage the electrical equipment in such a way that the arc won't be able to ignite.

### **Prefusion before alignment: EARLY PREFUSION**

The parameter EARLY PREFUSION is also specifically designed for the problems associated with carbon coated fibers. The carbon coating has a tendency to give off more material during arc ignition, and thus cause more build-up on the electrodes. To avoid this, you can set EARLY PREFUSION to ON, and the prefusion will occur before the fibers are brought close to the electrodes during alignment.

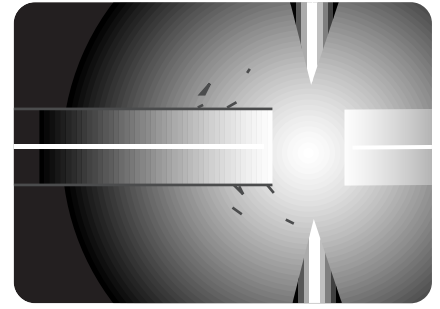

*Increased build-up on electrodes from carbon coated fiber*

### **Alignment accuracy: ALIGN ACCURACY**

Alignment is executed with the degree of accuracy specified in this parameter. There may be cases, however, where the splicing combination demands, or allows for, a greater, or lesser, degree of accuracy than the default of 0.15  $\mu\text{m}$ . You should keep in mind, though that increased accuracy is paid for in terms of the increased time it takes for the splicer to align the fibers.

## A Power connection

There are several maintenance tasks connected with keeping the FSU 975 supplied with power.

### Fuses

The fuses are located in the rear panel of the splicer (see diagram, p. 7). There is a 6A fuse intended for the splicer and heat oven, and a 2A fuse related to the outlet marked AUX. Both of them are delayed action fuses. When they must be replaced, you should carefully remove them with a screwdriver (see adjacent picture), and replace them with delayed action fuses of the correct amperage.



### Battery

The battery is delivered uncharged, so the first thing you must do with it is to charge it. To charge it, you should connect it to the power supply (input 90-264 V AC, output 12V DC). Note that it takes approximately ten hours to charge an empty battery, so plan in advance. Do not charge the battery for a longer period of time, since this will shorten the battery's lifetime. The other thing to note is that the battery will slowly discharge even when unused, so you should plan to routinely charge it once a month.



FSU 975 battery

While the battery is in use, the splicer will display the warning **LOW BATTERY** when the battery voltage is under 11.0 V. This is a signal to you that you will soon have to stop splicing with it, and recharge it. You can also check the battery voltage at any time by connecting it to the splicer, selecting manual mode (with the MODE button, see p. 14) and holding down the (#) button until the battery voltage is displayed.

“ **LOW BATTERY** ”

## B Fiber clamps and V-grooves

### Cleaning

In the case of both the fiber clamps and V-grooves, cleanliness is very important. Before starting work each day, you should clean them with a cotton swab dipped in propanol or ethanol. After you have finished cleaning them, you should also ensure that you have not left behind any strands of cotton. For V-grooves that become heavily dirtied, we recommend that you clean them in an ultrasonic cleaner.

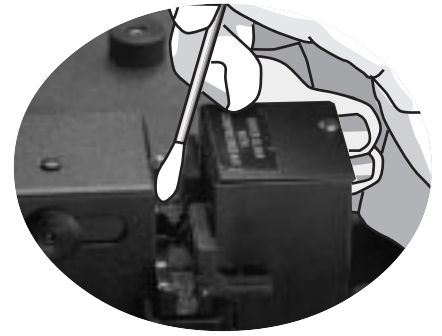

### Do's and do not's when cleaning

- Do NOT clean either the fiber clamps or the V-grooves with compressed gas. The combination of high pressure air and dust acts like a sandblaster on their precision surfaces.
- Do NOT use any sort of hard tool to clean either the fiber clamps or the V-grooves.
- ONLY clean with pure propanol or ethanol.

### Changing V-grooves

The FSU 975 comes with two pairs of V-grooves, blue and black, and based on the kind of fiber you are splicing you will have to periodically exchange them. To do so:

- ① Open the safety shield.
- ② Loosen the screw that fastens the V-grooves with the hex wrench supplied with the splicer (see first adjacent picture).
- ③ Pull out the old V-groove (see second adjacent picture).
- ④ Insert the new V-groove, making sure that the number printed on the V-groove agrees with the number indicated on the label behind the operator panel (see sample label below).
- ⑤ Tighten screw that holds V-groove. Do not fasten too tight.
- ⑥ Repeat procedure for the other V-groove.

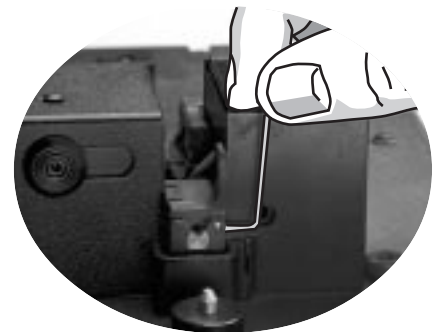

Unfasten screw

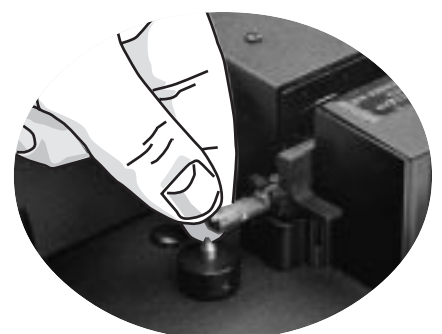

Exchange V-grooves

### V-groove numbers

Every FSU 975 V-groove has its own unique number, and can be used only with its particular FSU 975 splicer. The label behind the operator panel (see adjacent picture) identifies the V-grooves that go with that splicer. The reason for this specificity lies in the high precision of fabrication dimensions, and it means you cannot exchange V-grooves between splicers.

V-groove numbers		
	Left	Right
Blue	12345	56789
Black	54321	98765

## C Electrodes

### Cleaning

The electrodes can be cleaned in two different ways. The first is to run the electrode cleaning program (see also p. 57), which is accessed as follows:

#-button > "Clean electrodes?" > YES

The electrode cleaning program should be a part of your daily splicing routine, and we recommend it as a start-up procedure. You should also run it after every 20th splice.

While the electrode cleaning program is running, you should listen for a sizzling sound. If you hear it, you should run the program several times until it subsides. If the sound does not subside you should switch to the second way of cleaning the electrodes.

The second way of cleaning the electrodes is to make use of the electrode brush that comes with the splicer (see adjacent picture). You first brush away excessive deposits with this brush, and then run the electrode cleaning program. This cleaning procedure should be a more seldom activity, averaging around every 200th splice.

If a sizzling sound persists even after cleaning the electrodes with the brush and the electrode cleaning program, you probably have to replace them, which is explained subsequently.

Keep in mind that the electrode tips are **very fragile**, and thus you should never clean them with a hard object, and you should even keep to a minimum the frequency with which you clean them with the electrode brush.

### Changing

Under normal splicing conditions the electrodes must be replaced around every 2000th splice. However, if you are using certain types of fiber, such as carbon coated fiber, you will have to replace them more often.

As discussed on page 53, the FSU 975 has a built-in splice counter. When this counter reaches the value indicated in the global parameter ELECTROD WARNING, the splicer will display the warning CHECK ELECTRODE WEAR. This is your signal that you should probably change the electrodes using the procedure outlined on the next page. Don't forget that after you have changed them you must also run the electrode cleaning program several times and reset the splicing counter (to find it, see flow chart, p. 73).



To access electrode cleaning program

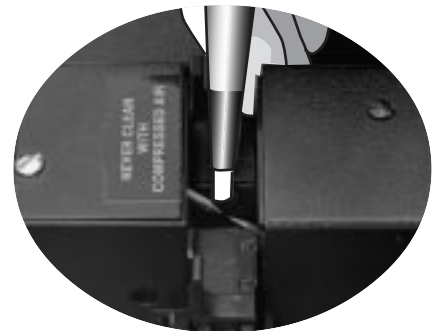

“  
CHECK ELECTRODE WEAR  
”

### Accessing electrodes:

Upper electrode (steps 1 - 4)

- ① Loosen the screw that holds in place the the outer cover of the electrode block. Remove the outer cover.
- ② Loosen the screw that holds in place the inner cover of the electrode block. Remove the inner cover.
- ③ With the hex wrench that comes with the splicer, loosen the two screws that fasten the upper electrode.
- ④ Lift the upper electrode out with the electrode tweezers that come with the splicer.

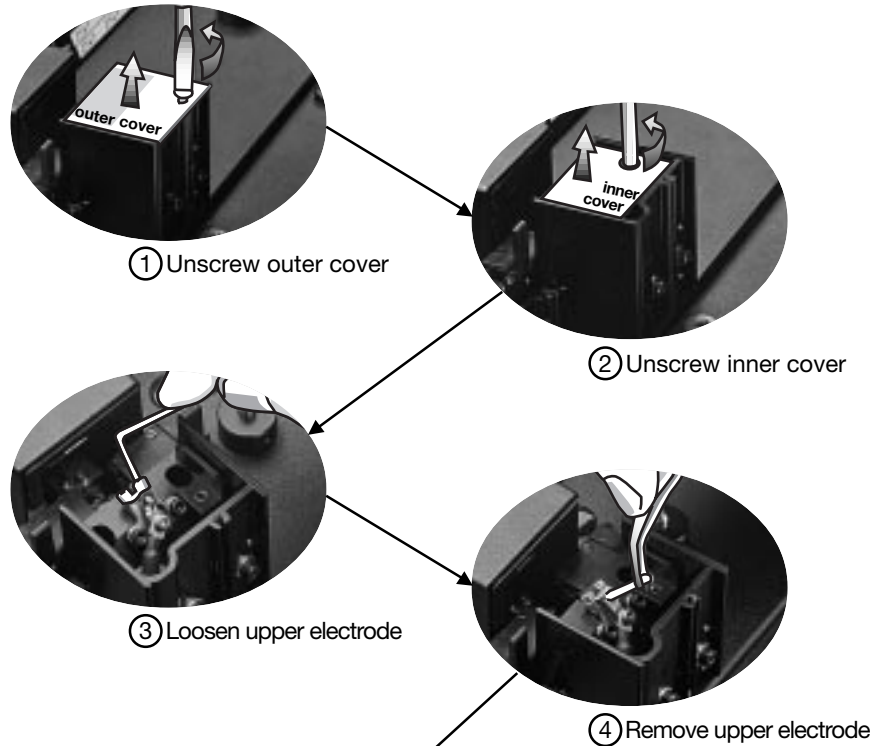

Lower electrode (steps 5 - 8)

- ⑤ Loosen and remove the knob on the right side of the cover over the optical house using the hex wrench that comes with the splicer.
- ⑥ Loosen the screws on top of the cover over the optical house. Remove the cover.
- ⑦ With the hex wrench that comes with the splicer, loosen the two screws that fasten the lower electrode.
- ⑧ Lift the lower electrode out with the electrode tweezers that come with the splicer.

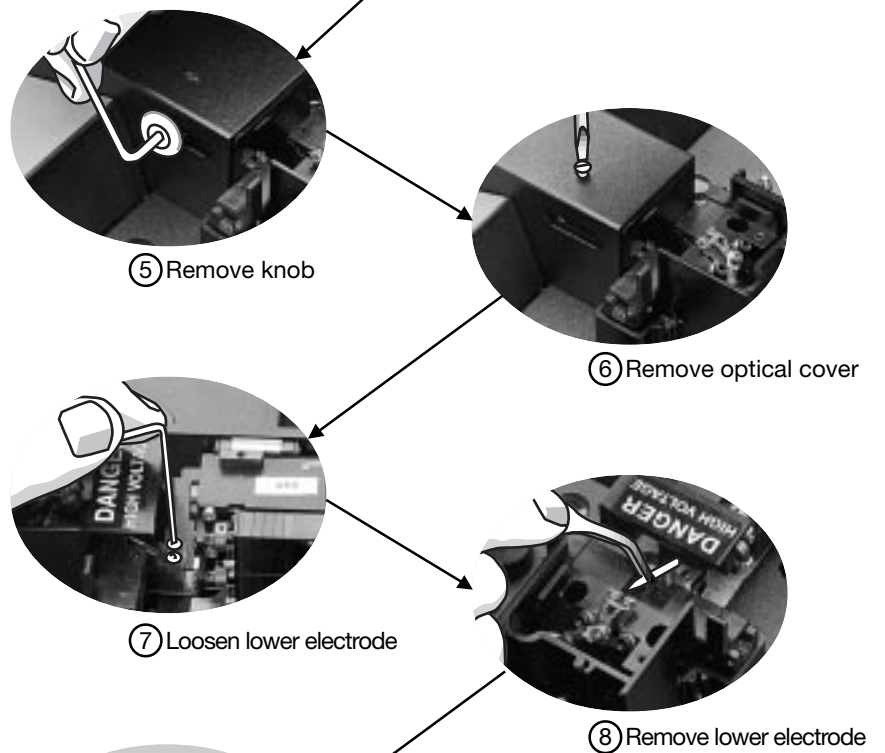

#### Keep in mind...

- The electrode tips are fragile, and you should avoid touching them.
- There is risk of damage to precision parts if you drop the electrodes into the splicer.
- You must reset the splicer counter yourself after replacing the electrodes.

Install the new electrodes by following the same procedure in reverse, starting with step 8 and going backwards to 1.

- Run the electrode cleaning program several times.

- Reset the splicing counter to 0 (see flow chart, p. 73).

## D Mirror one

Because of the position of the mirrors in the FSU 975 there is a tendency for mirror one to become dirty with build-up in the same way the electrodes do. This build-up manifests itself as a gradual darkening of the image in the lower view, as well as in the contraction of the hot image light intensity curves for this same view. **YOU SHOULD NOT TRY TO CLEAN THE MIRROR YOURSELF**, but rather should deliver the splicer to an authorized Ericsson representative for cleaning.

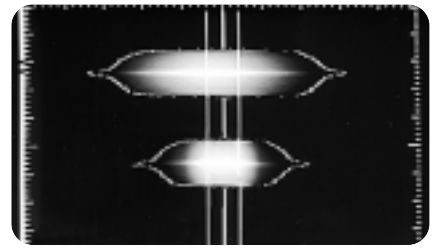

*Ex. of contraction of lower light intensity curve due to build-up on mirror one.*

## E Maintenance time table

Maintenance should be an important part of your daily routine with the FSU 975. To make it easier for you to keep in mind all of the various maintenance tasks, the following time table organizes these tasks according to how often you should do them.

How often	Maintenance tasks
Beginning of each day	Clean the electrodes using the electrode cleaning program. Clean the V-grooves with a cotton swab dipped in alcohol.
Every 20 splices	Clean the electrodes using the electrode cleaning program.
Every 200 splices	Clean the electrodes using the electrode brush and then the electrode cleaning program.
Every 1000 splices	Check mirror one for build-up.
Every 2000 splices	Replace the electrodes.

## Software package

For easier handling, the FSU 975 comes with a software package that allows you to control the operations of up to four FSU 975 splicers from a PC computer. Splicing program editing is also facilitated in that you can edit and store programs centrally on a PC, downloading them to individual splicers as needed.



**Program parameters**

Name and Type	Control parameters	Splicing parameters	PM parameters	Comment
Prefuse time	<input type="text" value="0.2"/> (second)	Fusion current 3	<input type="text" value="12.5"/> (mA)	
Prefuse current	<input type="text" value="10"/> (mA)	Left M.F.D.	<input type="text" value="9.8"/> (um)	
Gap distance	<input type="text" value="50"/> (um)	Right M.F.D.	<input type="text" value="9.8"/> (um)	
Fusion time 1	<input type="text" value="0.3"/> (second)	Set center position	<input type="text" value="225"/>	
Fusion current 1	<input type="text" value="10.5"/> (mA)	ADA current	<input type="text" value="0"/> (mA)	
Fusion time 2	<input type="text" value="2"/> (second)	<input type="checkbox"/> Early prefusion		
Fusion current 2	<input type="text" value="15"/> (mA)	Align accuracy	<input type="text" value="0.15"/>	
Fusion time 3	<input type="text" value="2"/> (second)	Overlap	<input type="text" value="8"/>	

Buttons: Send to FSU, Save to file, Set default, Close

*Example of the interface for splicing program editing*

## Appendix A - Troubleshooting

The following three tables present the fault messages that will appear when there is a problem, along with possible causes and suggested corrective messages. The first table applies to all splicing processes; whereas, the other two are specific to mode field matching and attenuator making respectively.

Fault message	Possible causes	Suggested corrective measures
LOW BATTERY	<ol style="list-style-type: none"> <li>1. The battery needs charging.</li> <li>2. The power supply is faulty.</li> <li>3. The splicer is measuring the battery charge incorrectly.</li> </ol>	<ol style="list-style-type: none"> <li>1. Charge the battery.</li> <li>2. Service the power supply.</li> <li>3. Service the splicer.</li> </ol>
CHECK ELECTRODE WEAR	The number of splices indicated in the global parameter "Electrode warning" have been executed.	Change the electrodes and reset the splice counter to zero.
NO FIBER FOUND	<ol style="list-style-type: none"> <li>1. The fibers are not in the cameras' field of vision.</li> <li>2. The fibers are out of focus.</li> <li>3. The optical system is faulty.</li> </ol>	<ol style="list-style-type: none"> <li>1. Insert the fibers so that they are clearly visible in the monitor.</li> <li>2. Adjust the focus.</li> <li>3. Service the splicer.</li> </ol>
NO LEFT FIBER FOUND	See NO FIBER FOUND.	See NO FIBER FOUND.
NO RIGHT FIBER FOUND	See NO FIBER FOUND.	See NO FIBER FOUND.
NO GAP FOUND	The splicer can not locate the end faces, or the gap between them.	Insert the fibers into the clamps again, and/or adjust the focus.
BAD LEFT GAP	The splicer cannot locate the end of the left fiber because of dirt or a poor cleaved end faces.	Adjust the focus, and if the problem persists, re-prepare the left fiber.
BAD RIGHT GAP	The splicer cannot locate the end of the right fiber because of dirt or a poor cleaved end faces.	Adjust the focus, and if the problem persists, re-prepare the right fiber.
BAD LEFT GAP ANGLE	The cleave angle of the left fiber is too large.	Re-prepare the left fiber paying special attention to cleaving.
BAD RIGHT GAP ANGLE	The cleave angle of the right fiber is too large.	Re-prepare the right fiber paying special attention to cleaving.
BAD FIBERS	<ol style="list-style-type: none"> <li>1. Monitor out of focus.</li> <li>2. The fibers are dirty.</li> <li>3. Poor end faces.</li> </ol>	<ol style="list-style-type: none"> <li>1. Adjust the focus.</li> <li>2. Re-prepare the fibers.</li> <li>3. Re-prepare the fibers paying special attention to cleaving.</li> </ol>
DIRTY FIBERS	The fibers are dirty.	Re-prepare the fibers paying special attention to properly cleaning them, and clean the V-grooves.
DIRTY LEFT FIBER	See DIRTY FIBERS.	See DIRTY FIBERS.
DIRTY RIGHT FIBER	See DIRTY FIBERS.	See DIRTY FIBERS.
CAN'T ALIGN VERY GOOD	<ol style="list-style-type: none"> <li>1. Monitor out of focus.</li> <li>2. Internal splicer error.</li> </ol>	<ol style="list-style-type: none"> <li>1. Adjust the focus.</li> <li>2. Service the splicer.</li> </ol>

Continued on the next page →

### General fault messages (cont.)

Fault message	Possible causes	Suggested corrective measures
CAN'T MAKE SHARP	1. Monitor out of focus. 2. Internal splicer error.	1. Adjust the focus. 2. Service the splicer.
BAD VIEW ANGLE	1. The V-grooves are dirty. 2. The V-grooves are out of alignment.	1. Clean the V-grooves. 2. Service the splicer.
INTERNAL ERROR	Splicer needs service.	Service the splicer.
CANNOT ESTIMATE LOSS	1. Bad splice picture. 2. Wrong parameters used in program. 3. If it happens very frequently, it means the optical system is faulty.	1. Re-fuse the fibers. 2. Check the program and program parameters, and then re-splice. 3. Service the splicer.
BAD SPLICE	Unsuccessful splice.	Re-splice the fibers.

### Mode field matching fault messages

Fault message	Possible causes	Suggested corrective measures
SELECT # NOT PRESSED COMPUTE THRESHOLD?	During the threshold type test, the #-button was not pressed, and thus no new loss data was saved.	To compute the threshold anyway, with the latest memorized data, press YES.
NO THRESHOLD FOUND DO SELECT NEXT TIME	Insufficient data for calculating a threshold type.	Re-do the test, paying special attention to taking data for splice loss measurement.
NO THRESHOLD FOUND TRY REDUCE TIME 2	Insufficient data for calculating a threshold type.	Reduce FUSION TIME 2 and re-do test.
NO THRESHOLD FOUND TRY INCREASE CURR. 2	Insufficient data for calculating a threshold type.	Increase FUSION CURRENT 2 and re-do test.
NO THRESHOLD FOUND TRY REDUCE CURR. 2	Insufficient data for calculating a threshold type.	Reduce FUSION CURRENT 2 and re-do test.
NO THRESHOLD FOUND TRY NORMAL PROCESS	Insufficient differences in index profiles to calculate a threshold type.	Try splicing with the normal splicing process.

When you have gotten a fault message and made note of what you should do, you can then return to the on-going procedure by pressing the ESC button.



## Attenuator making fault messages

Fault message	Possible causes	Suggested corrective measures
CANNOT ESTIMATE	If anything is wrong in the RTC procedure, the splicer will not give a loss estimation.	Press the ESC button twice to find out what is wrong with the RTC procedure.
FUSION CURR TOO HIGH	Fusion current 2 is too high, or the fusion time 2 too long, to allow RTC control.	Reduce FUSION CURR 2 by at least 1.0 mA.
RTC CURRENT TOO HIGH	Fusion current 3 is too high to allow RTC control.	Reduce FUSION CURR 3 by at least 1.0 mA.
RTC CURRENT TOO LOW	Fusion current 3 is too low to achieve the target offset.	Increase FUSION CURR 3 by at least 1.0 mA.
ECF FACTOR TOO SMALL	The ECF factor is too small to allow RTC control.	Increase ECF FACTOR by 0.2.

## Observable faults

There are also a set of possible problems in the operation of the splicer that you may observe visually. The following table outlines them as well as their possible causes and suggested solutions.

Problem	Possible causes	Suggested corrective measures
Arc unstable, splutters, or yellow in color.	<ol style="list-style-type: none"> <li>1. Electrodes dirty.</li> <li>2. Fibers dirty.</li> </ol>	<ol style="list-style-type: none"> <li>1. Clean and/or change the electrodes.</li> <li>2. Clean the fibers.</li> </ol>
Fibers bend out of alignment.	Fusion current too low.	Increase FUSION CURR 2.
One fiber out of focus	<ol style="list-style-type: none"> <li>1. Fiber out of alignment in other view.</li> <li>2. Dirt on primary coating, V-grooves, and/or fiber.</li> </ol>	<ol style="list-style-type: none"> <li>1. Align fiber in other view.</li> <li>2. Re-prepare the fibers paying special attention to cleaning both the fibers and V-grooves.</li> </ol>
Fibers twist up or down when inserted in clamps	Dirt on primary coating, V-grooves, and/or fiber.	Re-prepare the fibers paying special attention to cleaning both the fibers and V-grooves.
Splicer turns off or resets unexpectedly	<ol style="list-style-type: none"> <li>1. Battery run down.</li> <li>2. Power supply faulty.</li> <li>3. Main power unstable.</li> </ol>	<ol style="list-style-type: none"> <li>1. Charge the battery.</li> <li>2. Service the power supply.</li> <li>3. Use the battery.</li> </ol>
Fibers in hot images too close	<ol style="list-style-type: none"> <li>1. Dirt on primary coating, V-grooves, and/or fibers.</li> <li>2. Optical system faulty.</li> </ol>	<ol style="list-style-type: none"> <li>1. Re-prepare the fibers paying special attention to cleaning both the fibers and V-grooves.</li> <li>2. Service the splicer.</li> </ol>
Image in monitor dim or dirty	Mirrors are dirty.	Service the splicer.
White vertical line at splice point (see also p. 22 for other splice problems)	<ol style="list-style-type: none"> <li>1. Poor cleave end faces.</li> <li>2. Wrong current</li> <li>3. Bad cleaning liquid</li> </ol>	<ol style="list-style-type: none"> <li>1. Re-cleave the fibers.</li> <li>2. Adjust current.</li> <li>3. Be sure you are only using pure propanol or ethanol.</li> </ol>

## Appendix B - Technical data

### FSU 975 Technical data

<b>Fibers</b>	Single fiber with a cladding diameter: 30 - 270 µm in Automode (automatic alignment) 30 - 400 µm in Manual mode (manual alignment) Single fiber with cladding diameter up to 2000 µm Special single fibers including erbium, dispersion shifted and multimode
<b>Splice loss</b>	Typical value using identical single mode fibers: 0.02 dB
<b>Fiber clamping</b>	On bare fiber with blue V-grooves On primary coating with black V-grooves
<b>Power supply</b>	90 - 264 V AC, 50 - 60 Hz 13.2 V DC
<b>Battery</b>	Splicer only: greater than 100 splices per charge Splicer and heat oven: greater than 50 splices per charge Recharging time: 10 hours
<b>Operating environment</b>	0 - 40°C, 0 - 95% RH (non-condensing)
<b>Storage environment</b>	-40 - 60°C, 0 - 95% RH (non-condensing)
<b>Monitor</b>	3" high-resolution LCD monitor
<b>Video output</b>	1 V p-p positive, 75 ohms/CCIR
<b>Size</b>	37 x 22 x 14.5 cm (W x D x H) (approx. 14.6 x 8.7 x 5.7 in)
<b>Weight</b>	6.45 kg (without power supply) (approx. 14.2 lbs.)
<b>Transport casing</b>	Rugged cabin-sized case with space for all necessary accessories (54.5 x 42.5 x 25.5 cm (approx. 21.5 x 16.7 x 10 in) W x D x H, upright)

#### AUX-connector pin description

1	Power ground
2	Not used
3	Not used
4	Composite video
5	Video ground
6	Disable FSU 975 OFF-button (active low) (To prevent external units from losing power when using internal power from FSU 975)
7	Optional
8	Not used
9	Power: +12 V DC, Fuse 2A

*The AUX-connector is intended for external units such as a larger monitor.*

#### RS 232 pin description

1	Power ground
2	T x D (Transmit data)
3	R x D (Receive data)
4	RTS (Request to send)
5	To CPU-board (No function)
6	To CPU-board (EXTM-signal)
7	Not used
8	CTS (+12 V, pull-up 1 ko)
9	Power: +12 V DC, Fuse 2A

*The RS 232 is intended for serial communication with a PC or printer.*

# Appendix C - Parameter and program editing flow charts

The following flow charts are provided to the advanced user as a concise summary of the capabilities of the FSU 975. With a mastery of the FSU 975 interface and technique, one can use these flow charts to quickly locate parameters and functionality within the splicer's software.

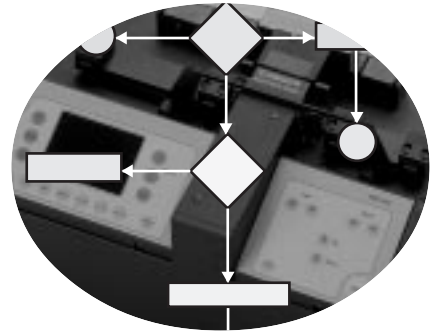

Below is a key to understand the symbols used within the flow charts. The flow charts themselves are presented in the following order:

Global parameters ..... 73  
 Program editing ..... 74  
 Service functions ..... 76

## Key to flow charts

Splicelist handling?

Questions that require a YES or NO answer as response are indicated with a rectangle.

Fusion current 1 10.5 mA

Quantitative parameters that require you to enter a value and then press ENTER are indicated with an oval. The editable area is indicated with a grey box.

Binary parameters which you toggle off and on with the YES and NO buttons and then select a state by pressing ENTER, are indicated in the same fashion.

Open!?  
Read Only?  
Confidential?

Parameters with multiple values that require you to scroll through the list by pressing NO, and then selecting the desired value by pressing ENTER (see p. 51), are indicated by a rounded box including the list of possible parameter values.



YES button



NO button



ENTER button



#-button

"Parameter updating..."

Any messages the splicer displays that don't require responses will be indicated in quotations marks.

*Resets splice counter to 0*

Any explanatory information will be indicated with italics.



The pages are organized with white areas which contain the main editing blocks, and grey areas which present the editable parameters within each of these blocks. (For more about navigation, see p. 50)

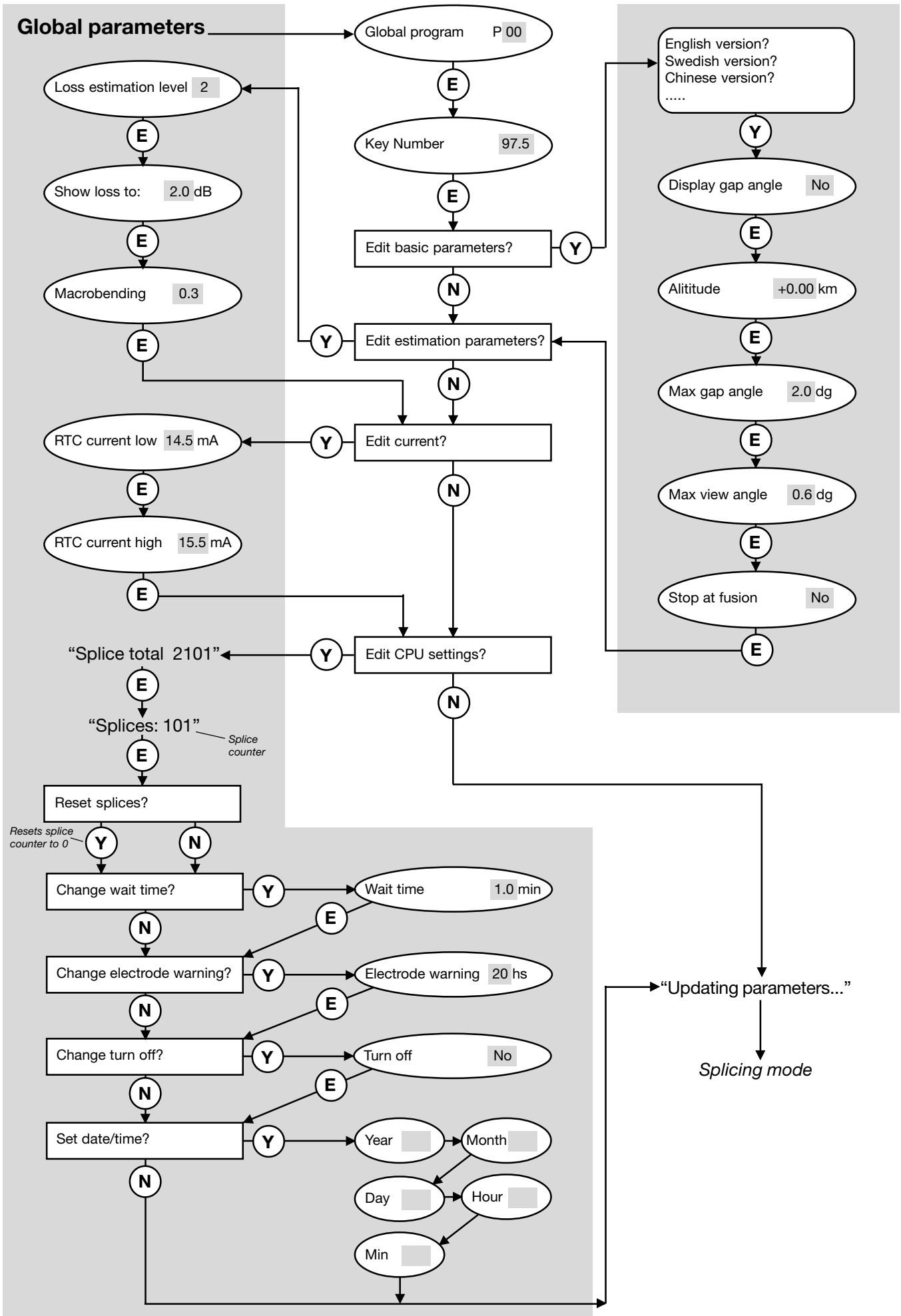

# Program editing

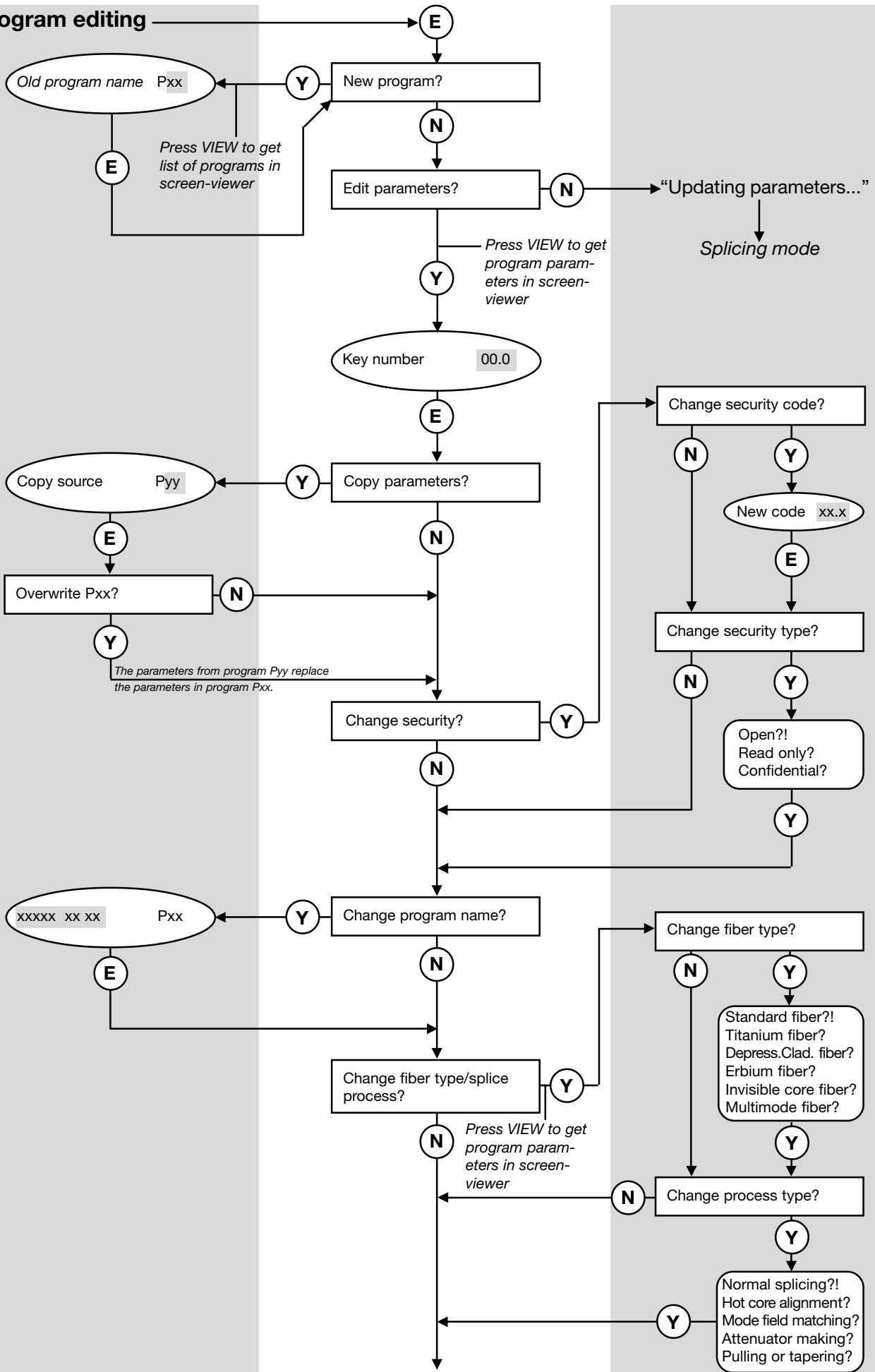

Continued on next page

Continued from previous page

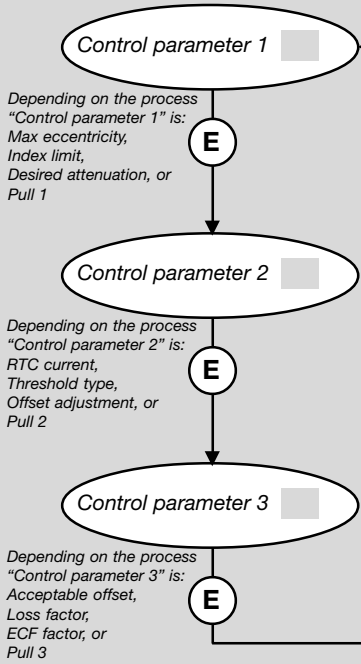

Change security?

Follow from same question in the middle of the previous page

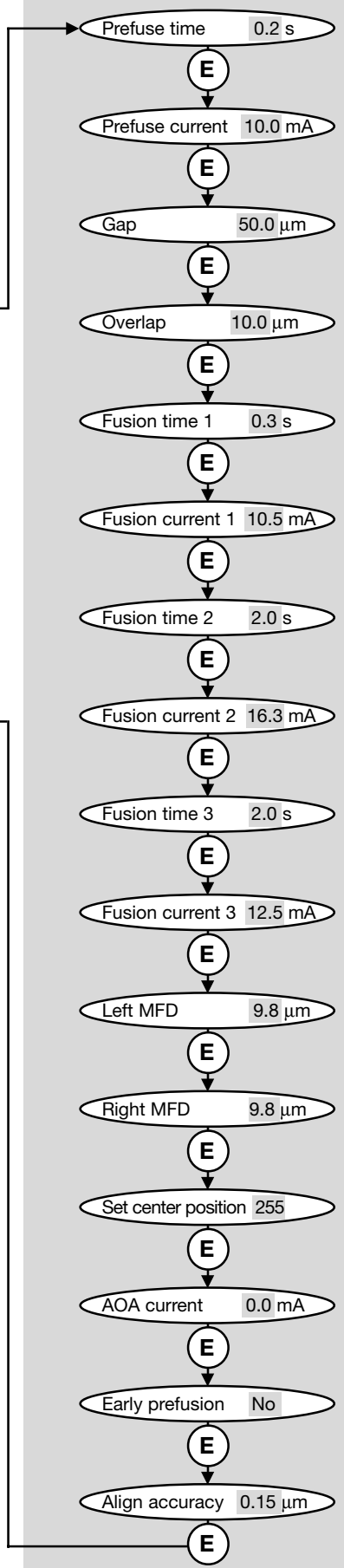
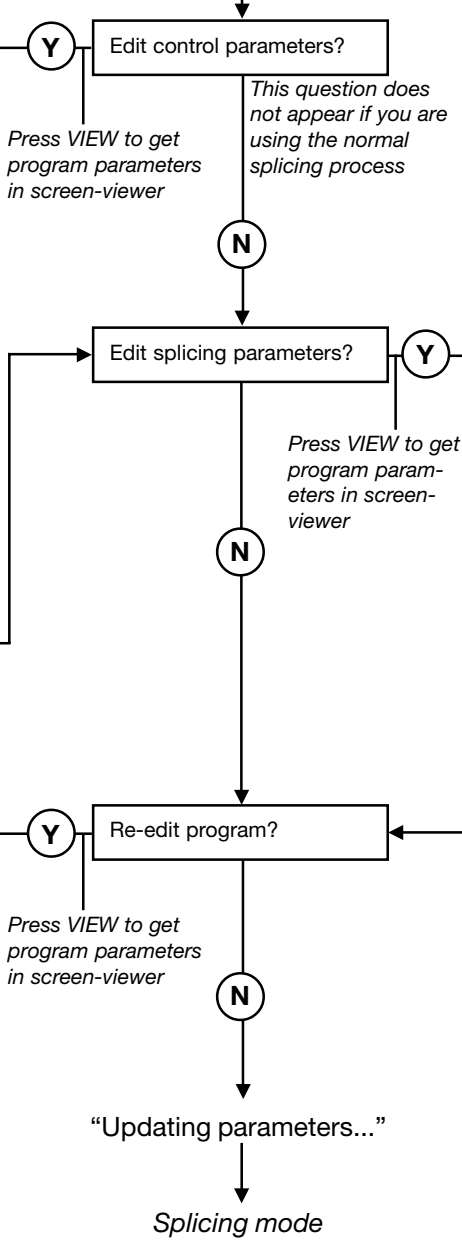

# Service functions

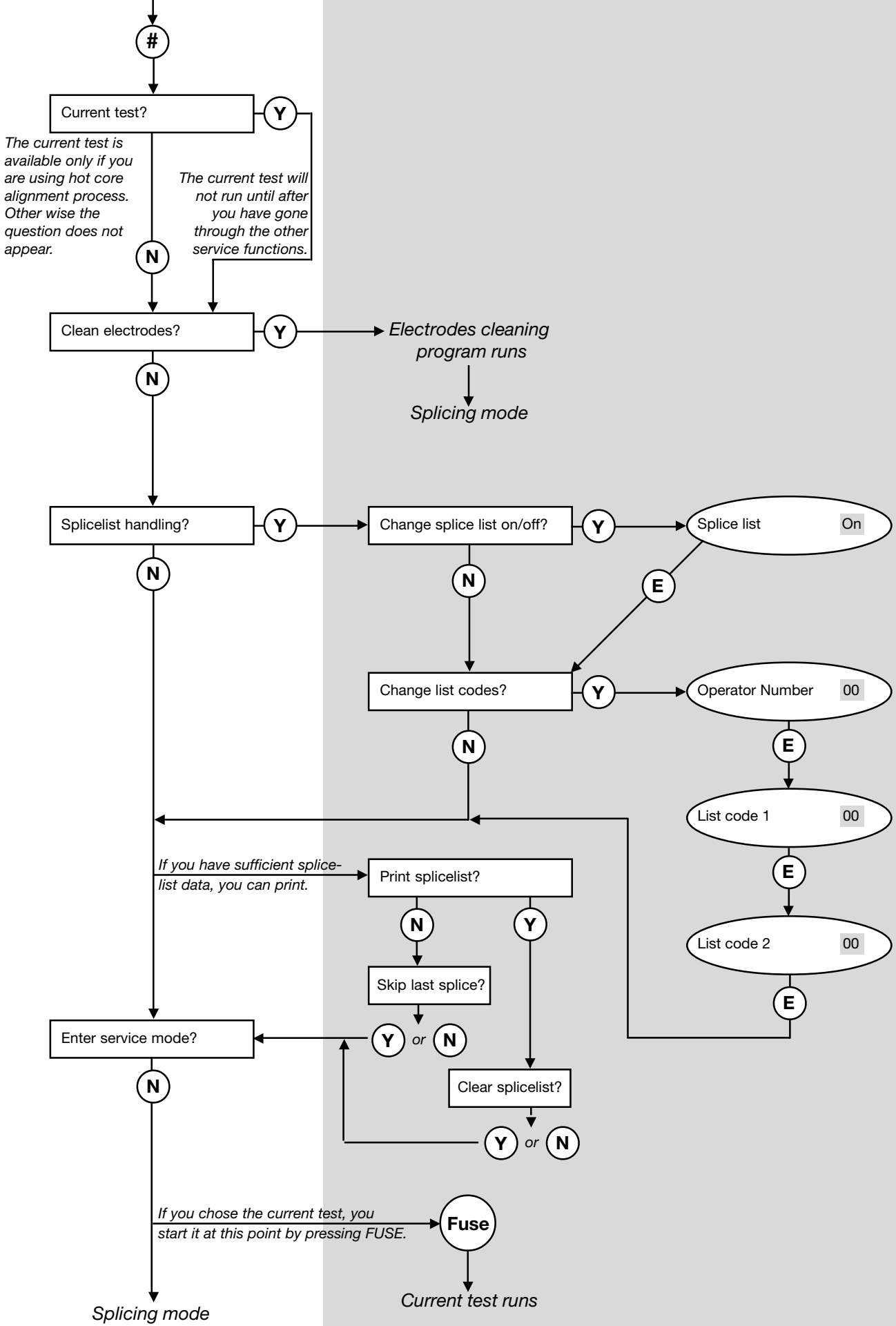

## A

Acceptable offset 29, 35  
 Align accuracy 37, 61  
 Alignment  
   fine 17, 19, 20  
   rough 17, 18  
 Altitude, compensation for 52, 55  
 AOA current 37, 60  
 Arrow buttons 7, 18, 44  
 Attenuator making. *See Splicing processes: attenuator making*  
 Automode 12, 14  
 AUX-connector 71

## B

Base line tilting 59  
 Battery 8  
   charging 62  
   checking voltage 62  
   low level warning 62  
 Binary parameter values 51  
 Buttons (overview) 7

## C

Carrying case 5, 6  
 Character selection 44. *See also Quick character selection*  
 Cleaning  
   electrodes 64  
   fiber clamps 63  
   fiber during preparation 10  
   V-grooves 10, 63  
 Cleave angle. *See Gap angle*  
 Cleaving 11  
   cleaving lengths 11  
 Control parameters 35, 46  
 Core 22  
   eccentricity 22, 28, 29, 35  
 Core deformation 59  
 CPU settings 53  
 Current test 56

## D

Date/time 53  
 Desired attenuation 32, 35  
 Display gap angle 52, 54

## E

Early prefusion 37, 61  
 ECF factor 32, 35  
 Electrode brush 6  
 Electrode warning 53  
 Electrodes 6  
   changing 65  
   cleaning program 5, 57, 64  
   maintenance 5, 64  
   safety 5  
 Enter button 50  
 Erbium splicing. *See Splicing processes: erbium splicing*  
 Escape button 7, 17  
 External monitor 71

## F

Fault messages 17, 68  
 Faults, observable 70  
 Fiber clamps 6, 12, 23  
   maintenance 63  
 Fiber fixtures 6, 23  
 Fiber insertion 12  
 Fiber preparation 10  
   defects 13  
 Fiber types 26, 34, 45  
   depressed cladding 27  
   dispersion shifted 27  
   erbium 26  
   invisible core 27  
   multimode 26  
   silica core 27  
 Focusing monitor 7  
 Fuse button 7, 17, 20  
 Fuses 7  
   replacing 62  
 Fusion current parameters 36  
 Fusion time parameters 36

## G

Gap 36  
 Gap angle 54  
 Gap button 7, 19  
 Global parameters 52

## H

Heat oven 6, 23  
 Heat-shrinkable sleeve 10, 23  
 Hot core alignment 21, 22. *See Splicing processes: hot core alignment*  
 Hot fiber index profile 30  
 Hot images 4, 21, 22, 59  
   button 7  
 Humidity 5

## I

Index limit 30, 35  
 Index profile. *See Hot fiber index profile*

## K

Key number. *See Security*

## L

Language, changing 52  
 Left MFD 32, 37, 60  
 Light intensity curves 59  
 Live images 21  
 Loss estimation level 53  
 Loss factor 30, 35

## M

Macrobending 53  
 Maintenance 5, 62  
   battery 62  
   electrodes 64  
   fiber clamps 63  
   fuses 62  
   mirror one 66  
   time table 66  
   V-grooves 63  
 Manual mode 14  
 Matchsticking 27. *See also Splicing defects*  
 Max eccentricity 29, 35  
 Max gap angle 52  
 Max view angle 52  
 Message field 7, 40

Mirror one 66  
Mode button 7, 14  
Mode coupling theory 4  
Mode field 7, 40  
Mode field diameters 30, 32, 60  
Monitor  
    controls 7  
    description 7  
Multiple value parameters 51

## N

Navigation 50  
No button 50  
Number buttons 50

## O

Offset adjustment 32, 35  
On/Off button 7  
Overlap 36

## P

Parameter editing review 50  
Power  
    connecting 8  
    input 7, 8  
    supply 8  
Pre-defined programs. *See*  
    *Splicing programs: Programs*  
    *01-10*  
Prefuse current 36  
Prefuse time 36  
Prefusion 17, 19  
Printer connection 71  
Printing splice-lists 58  
Program editing mode 41  
Program parameters 34  
    general 34  
    control. *See* *Control parameters*  
    splicing. *See* *Splicing param-*  
    *eters*  
Programming buttons 7  
Programs 01-10. *See* *Splicing*  
    *programs: Programs 01-10*  
Programs 11-50. *See* *Splicing*  
    *programs: editable*  
Pull parameters 33, 35

## Q

Quantitative parameter values 51  
Quick character selection 52

## R

Real time control (RTC) 29, 32  
Rear panel 7  
Right MFD 32, 37, 60  
Rough alignment 17, 18  
RSR 232 7, 71  
RTC current 29, 35, 56  
    RTC current high 53  
    RTC current low 53  
RTC cycles 32

## S

Safety 5  
Safety shield 5, 6, 12, 13  
Screen viewer 15, 16  
Security 41, 43  
    code 34, 43  
    type 34, 43  
Service functions 56  
Service mode 58  
Set center position 37, 60  
Set-up checklist 8  
Show loss to 53  
Software 6, 67  
Source program 42  
Splice counter 53, 64  
Splice evaluation 21  
Splice loss 4, 21  
    estimation 21  
Splice loss estimation 4  
    parameters 53  
Splice protection 23  
Splice-list handling 57  
    list codes 57  
    operator number 57  
    printing out 58  
Splicing mode (definition) 16  
Splicing mode selection 14  
Splicing parameters 36, 48  
Splicing processes 4, 28, 34, 46  
    attenuator making 4, 16, 32, 35  
    erbium splicing 4, 26, 30  
    hot core alignment 16, 29, 35  
    mode field matching 16, 30, 35  
    normal 16, 28  
    pulling or tapering 4, 16, 33, 35

Splicing programs  
    editable 4, 40  
    naming 26, 34, 44  
    Programs 01-10 4, 16, 26, 38  
    selection 14  
Splicing quick guide 9  
Stop at fusion 52  
Stripping 10  
Surface tension 29, 32, 35

## T

Tapering. *See* *Splicing processes:*  
    *pulling or tapering*  
Target offset 32, 35  
Threshold type 30, 35  
    difference 31  
    higher index 31  
    higher start 31  
    left index 31  
    right index 31  
Threshold type test 30, 31  
Tool set 6  
Turn off 9, 53

## V

V-grooves 6, 8, 12  
    black 6, 8, 11  
    blue 6, 8, 11  
    changing 63  
    maintenance 5, 63  
    numbers 63  
Video output 7  
View angle 54  
View button 50  
Viewing fibers 7

## W

Wait time 53

## Y

Yes button 50

# Ericsson representatives

## Argentina

Reycom electrónica S.A.  
Bernardo de Irigoyen 972 Piso 6°  
1304 Buenos Aires  
tel: (54-1) 307-2185

## Belgium

Phase-Optic S.A.  
Z. A. de Vaubesnard  
7 chemin de Vaubesnard  
F-91410 Dourdan France  
tel: +33 1 645512 00

## Brazil

ASGA Microelectrónica S.A.  
Rodovia Dr. Roberto Moreira  
Km 4-CP 132  
13140-000 Paulínia, SP  
tel: 55 19 8442020

## Canada

Amherst Fiber Optics  
Brentwood Commons Two,  
Suite 205  
750 Old Hickory Blvd.  
Brentwood, TN 37027 USA  
tel: +1 (615) 376-4396

## China

Wall International Group  
Vantone Plaza, Room B1606  
No. 2 Fu Cheng Men Wai  
Street  
Beijing 100037  
tel: 86 10 68579091

## Czech Republic

HKE, spol. s.r.o.  
Na Cikorce 3  
CZ-143 00 Prague 4  
tel: 420 2 402 6889

## Denmark

Ericsson Components Dist.  
Sluseholmen 8  
DK-1790 Copenhagen V  
tel: +45 33883101

## Finland

Viikinkikaapeli Oy  
Sierakiventie 8  
SF-02780 Espoo  
tel: +358 9 299 65 00

## France

Phase-Optic S.A.  
Z. A. de Vaubesnard  
7 chemin de Vaubesnard  
F-91410 Dourdan  
tel: +33 1 64551200

## Germany

Macrotron Systems  
Ammerthalstrasse 7  
D-85551 Kirchheim  
tel: +49 8 945 111 283

## Hong Kong

Comtec  
Far East Reg Office  
Rm. 607, Austin Tower, 22-26A  
Austin Ave.  
Tsim shatsui, Kowloon  
tel: +852 23 112 263

## India

Subex Systems Ltd.  
721, 7<sup>th</sup> Main  
Mahalaxmi Layout  
Bangalore – 560 086  
tel: +91 80 3327581

Ericsson Comm. Pvt. Ltd.  
The Great Eastern Plaza  
2-A Bhikaji Cama Place  
New Delhi 110 066  
tel: +91 11 6180808

## Indonesia

Ericsson Indonesia P.T.  
Wasma Pondok Indah, 10<sup>th</sup> Fl.  
JL Sultan Iskandar  
Muda V. TA  
Jakarta 12310  
tel: 62 21 7693555

## Italy

Advance Italia Srl  
Via F. Ili Cernuschi 22  
I-22055 Merate (LC)  
tel: +39 039 990 7612

## Japan

Seiko Instruments Inc.  
8, Nakase 1-chome  
Mihama-ku  
Chiba-shi  
Chiba 261-8507  
tel: +81 043-211-1337

## Malaysia

Communication Techn. Sdn  
Bhd  
No 6, Lot 291, Jalan TP5  
Taman Perindustrian UEP  
47600 Petaling Jaya  
Selangor Darul Ehsan  
tel: 6 037 047 888

## Mexico

Amherst Fiber Optics  
Brentwood Commons Two,  
Suite 205  
750 Old Hickory Blvd.  
Brentwood, TN 37027 USA  
tel: +1 (615) 376-4396

## The Netherlands

Rexcom Holland B.V.  
Patroonstraat 11  
NL-3860 BC Nijkerk  
tel: +31 33 246 12 44

## Norway

FOSS AS  
Kobbervikdalen 93B  
Postboks 3614  
N-3007 Drammen  
tel: +47 32 21 08 15

## Philippines

Ericsson Telecomm. Inc.  
7<sup>th</sup> Floor Octagon Bldg.  
San Miguel Avenue  
Ortigas Center  
PO Box 136 43  
Pasig City 1600  
tel: 63 2 6371600

## Poland

P.U.H. Interlab s.c.  
ul. Potocka 14  
Pawilon 3  
PL-01-641 Warsaw  
tel: +48 22 8333956

## Singapore

Tele Dynamics Pte Ltd  
BLK 9010, Tampines St 93  
#03 - 107  
Singapore 52 884  
tel: 6 578 628 888

## South Africa

Lambda Test Equipment c.c.  
PO Box 113  
Pespsequor Technopark  
Pretoria 0020  
tel: +27 12 3491341

## South Korea

ATC Electronics  
99-1 Nackwon-Dong  
Chongro-Gu  
Seoul  
tel: +82 27651177

## Sweden

Interscandinavia Telecom AB  
Jakobs Westins gatan 1B  
S-104 22 Stockholm  
tel: +46 8 441 1995

## Switzerland

Ericsson AG  
Stationstrasse 5  
CH-8306 Bruttisellen  
tel: +41 1 8053314

## Taiwan

Rock & Brothers Ent. Ltd.  
No19-1, Lane 1  
Alley 176  
Fu Ten One (1) Road  
Hsichin Chew  
Taipei Hsiew  
tel: 866226931888

## Thailand

Ericsson Thailand Ltd  
21st floor, The Suntowers Bldg B  
123 Vibhavadee Rangsit Rd.  
Chatuchak 109 00  
Bangkok  
tel: +66 2 2997000

## Turkey

Ericsson Telekomunikasyon AS  
Branch Office  
Cinnah Caddesi  
No. 41/10-13  
06680 Cankaya  
Ankara  
tel: +90 3126151500

## Tele Site

Telekommunikasyon Ltd.  
Nenehatun Caddesi 28/2  
Gaziosmanpasa  
067 00 Ankara  
tel: +90 3124472500

## United Kingdom

Comtec Cable Accessories Ltd  
Norman Way Ind. Estate  
Over, Cambridge CB4 5QE  
tel: +44 1 954 232 056

## United States

Amherst Fiber Optics  
Brentwood Commons Two,  
Suite 205  
750 Old Hickory Blvd.  
Brentwood, TN 37027  
tel: +1 (615) 376-4396

## Uruguay

Reycom electrónica S.A.  
Bernardo de Irigoyen 972 Piso 6°  
1304 Buenos Aires  
Argentina  
tel: (54-1) 307-2185

**Ericsson Cables AB**  
Network Products  
Landsvägen 66  
S-172 87 Sundbyberg, SWEDEN  
Tel:+46 8 764 0900  
Telex: 14723 ERINET S  
Telefax:+46 8 98 5503

89ST018 R1E  
© Ericsson Cables AB